

## CLiP 6

INTERIOR LED LINEAR LIGHTING, HIGH LUMEN  
INTEGRAL POWER SYSTEM



### APPLICATION

The C6C linear LED product line is designed for high lumen cove lighting, wall washing and wall grazing. Designed with modular CLiP<sup>®</sup> (Configurable Lighting Platform), C6C provides multiple optics, power & dimming options to suit multiple application requirements.

### CONSTRUCTION

- Aluminum housing/heat sink in light gray with matching injection molded plastic optics holder
- Available in section lengths of 1ft, 2ft or 4ft sections joinable for extended linear runs.
- Connect multiple 1 footers together to make serpentine curves and bends.
- Housings clip into fixed mounting brackets or adjustable angle brackets that rotate up to 90°
- Fully compliant with NEC Article 400
- CSA damp location listed

### OPTICS / LENS / DIFFUSER

- UV stabilized polycarbonate lens
- Optics Options:  
10°x10° / 10°x30° / 10°x60° / 15°x35° / 25°x25°  
25°x45° / 25°x75° / 40°x60° / 55°x25° / 120°x120°  
(Asymmetric optic coming soon)
- Optional Asymmetric, Symmetric or Honeycomb Louvers made of high impact, UV stabilized, non-corrosive textured polycarbonate

### POWER SYSTEM

- 12w, 9w & 5w per foot integral drivers.  
5w/ft meets ASHRAE standards for linear lighting.
- Universal 120V-277V Input
- ELV or Triac dimming to 1% (120V)
- 0-10V dimming with tempo Dimming Interface Module (DIM-Z)

### PERFORMANCE

- Operating temperature range of -20°C to 50°C
- Power Supply Total Harmonic Distortion <20%, Power Factor >0.9

### LIGHT CHARACTERISTICS

- Typical CRI of 80+ in 2700K to 5000K; plus static Red, Green & Blue.
- 90+ CRI option available with 2700K, 3000K and 3500K.
- LED's are selected and placed on the printed circuit boards via Tempo Industries' UniBin<sup>®</sup> process which ensures consistent hue and color within the entire installation. Color variations are held to a minimum, within a 2-step MacAdam ellipse.

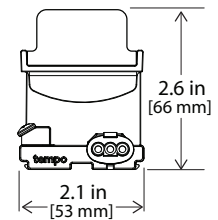

**Buy Tempo**  
**Buy American**

**MADE IN USA**  
OF US AND IMPORTED COMPONENTS

### WARRANTY

Tempo provides a 5-year limited warranty.

### 86,000 HOURS

**L85 LUMEN MAINTENANCE**  
LED Luminaires will reach 85% of initial lumens output at or beyond 86,000 hours at 25°C.



### PERFORMANCE SUMMARY All data nominal. 3500K test data shown.

|             | 10° x 10° |     |       | 10° x 30° |     |       | 10° x 60° |     |       | 15° x 35° |     |       | 25° x 25° |     |      | 25° x 45° |     |     |
|-------------|-----------|-----|-------|-----------|-----|-------|-----------|-----|-------|-----------|-----|-------|-----------|-----|------|-----------|-----|-----|
| Watts/ft    | 5         | 9   | 12    | 5         | 9   | 12    | 5         | 9   | 12    | 5         | 9   | 12    | 5         | 9   | 12   | 5         | 9   | 12  |
| Lumens/ft   | 440       | 976 | 1,374 | 411       | 911 | 1,284 | 405       | 900 | 1,267 | 344       | 718 | 1,002 | 440       | 873 | 1080 | 410       | 819 | 960 |
| Lumens/Watt | 115       | 119 | 112   | 107       | 111 | 104   | 105       | 109 | 103   | 89        | 87  | 82    | 88        | 97  | 90   | 82        | 91  | 80  |

|             | 25° x 75° |     |      | 40° x 60° |     |     | 55° x 25° |     |     | 120° x 120° |     |     |
|-------------|-----------|-----|------|-----------|-----|-----|-----------|-----|-----|-------------|-----|-----|
| Watts/ft    | 5         | 9   | 12   | 5         | 9   | 12  | 5         | 9   | 12  | 5           | 9   | 12  |
| Lumens/ft   | 380       | 756 | 1050 | 455       | 783 | 912 | 395       | 801 | 948 | 410         | 702 | 840 |
| Lumens/Watt | 76        | 84  | 75   | 91        | 87  | 76  | 79        | 89  | 79  | 82          | 78  | 70  |

## CLIP 6

INTERIOR LED LINEAR LIGHTING, HIGH LUMEN  
INTEGRAL POWER SYSTEM

### ORDERING INFORMATION

| C6C           |                | UNV                 | ET  |   |                                 |  |   |  |
|---------------|----------------|---------------------|---|---|---------------------------------|--|---|--|
| Series        | Optic          | Voltage             | Dimming   | Watts/Foot                                    | Color Temp                      | Finish   | Fixture Length  |  |
| <b>CLIP 6</b> | <b>10X10</b>   | <b>UNV</b> 120-277V | <b>ET</b> ELV or Triac<br><br><i>Dim to 1% (120V)</i> | <b>12</b> 12W<br><b>9</b> 9W<br><b>5*</b> 5W* | <b>27</b> 2700K (CRI 80+)       | <b>LG</b> Light Gray<br><br><b>BK</b> Black<br><b>WH</b> White<br><b>CC</b> Custom | <b>1</b> 1 foot<br><b>2</b> 2 foot<br><b>4</b> 4 foot |  |
|               | <b>10X30</b>   |                     |   |   | <b>30</b> 3000K (CRI 80+)       |  |   |  |
|               | <b>10X60</b>   |                     |   |   | <b>35</b> 3500K (CRI 80+)       |  |   |  |
|               | <b>15X35</b>   |                     |   |   | <b>40</b> 4000K (CRI 80+)       |  |   |  |
|               | <b>25X25</b>   |                     |   |   | <b>50</b> 5000K (CRI 80+)       |  |   |  |
|               | <b>25X45</b>   |                     |   |   | <b>RD</b> Red                   |  |   |  |
|               | <b>25X75</b>   |                     |   |   | <b>GR</b> Green                 |  |   |  |
|               | <b>40X60</b>   |                     |   |   | <b>BL</b> Blue                  |  |   |  |
|               | <b>55X25</b>   |                     |   |   | <b>27H</b> 2700K (High CRI 90+) |  |   |  |
|               | <b>120X120</b> |                     |   |   | <b>30H</b> 3000K (High CRI 90+) |  |   |  |
|               |                |                     |   |   | <b>35H</b> 3500K (High CRI 90+) |  |   |  |

\* 5W/ft meets ASHRAE standards for linear lighting.

### SYSTEM INTEGRATION ACCESSORIES

|   |                       |  |
|---|-----------------------|--|
| <b>SURGE SUPPRESSION DEVICE</b> Tempo furnished surge suppression device must be installed on each supplying branch circuit to comply with 5-year warranty. |                       |  |
|   | SSD-120               | 120V Branch Circuit  |
|   | SSD-277               | 277V Branch Circuit  |
| <b>DIMMING INTERFACE MODULE (DIM-Z)</b> 600W max at 120V and 1350W max at 277v. See tempollc.com for full specifications.                                   |                       |  |
|   | DIM-Z                 | Dimming Interface Module converts 0-10V dimming signals to ELV Dimming output, 120 - 277 Universal Line Voltage. DIM-Z used with the ET driver limits dimming to 1%. |
| <b>POWER FEED CABLES</b> Additional lengths available, contact factory  |                       |  |
|   | PFC6-F-36             | Female connector, 36 inches  |
| <b>JUMPER FEED CABLES</b> Additional lengths available, contact factory   |                       |  |
|   | JFC6-FM-12            | Female/Male connector, 12 inches   |
|   | JFC6-FM-18            | Female/Male connector, 18 inches   |
|   | JFC6-FM-24            | Female/Male connector, 24 inches   |
| <b>MOUNTING HARDWARE</b>  |                       |  |
|   | C6A-MC                | Stainless Steel Surface Mount Clips for up lighting applications only, (set of 12). Max spacing 18"  |
|   | C6A-IMB               | Stainless Steel Inverted Mounting Bracket for down light & wall mount, (set of 12). Max spacing 18"  |
|   | C6A-MTGBRKT-1020      | Plastic Mounting Bracket with 10° or 20° angle (set of 12). Max spacing 18"  |
|   | PA-8                  | Aluminum 90°+ Adjustable Mounting Bracket. Minimum of 2 required per section.  |
|   | ROT-MTGBRK-C6/C6RX-NA | Cast Aluminum 100° Rotational Mounting Bracket (set of 2). Minimum of 2 required per section.  |
| <b>GLARE CONTROL</b>  |                       |  |
|   | GS-C6C-A-BK           | 1 foot Asymmetric Louver, Black  |
|   | GS-C6C-S-BK           | 1 foot Symmetric Louver, Black   |
|   | GS-C6C-H-BK           | 1 foot Honeycomb Louver, Black   |

## CLiP 6

INTERIOR LED LINEAR LIGHTING, HIGH LUMEN  
INTEGRAL POWER SYSTEM

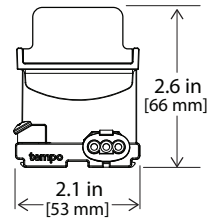

### DIMENSIONAL INFORMATION

#### C6C 1FT

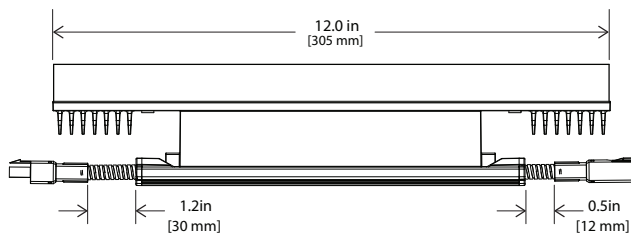

#### C6C 1FT CONNECTED SERPENTINE RUNS

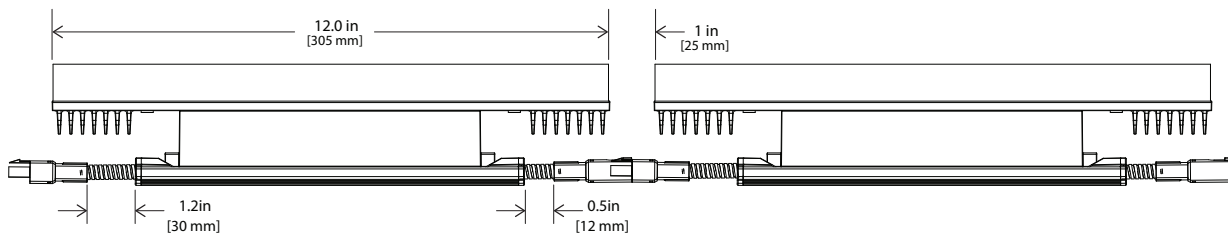

#### C6C 2FT & 4FT

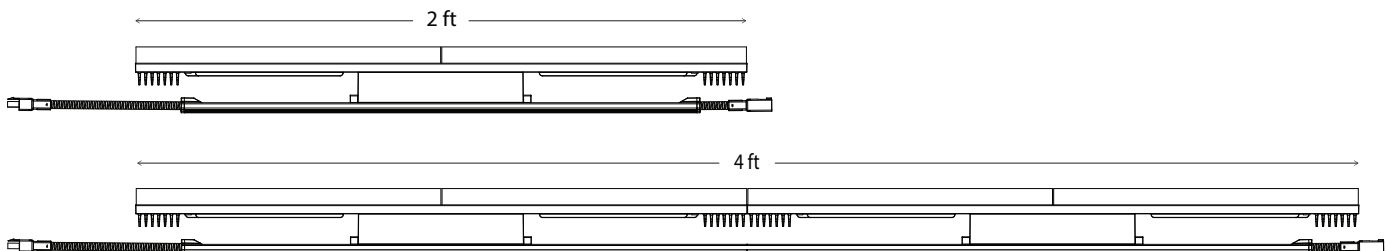

## CLIP 6

INTERIOR LED LINEAR LIGHTING, HIGH LUMEN  
INTEGRAL POWER SYSTEM

### SERPENTINE CURVES & BENDS WITH 1 FOOT C6C

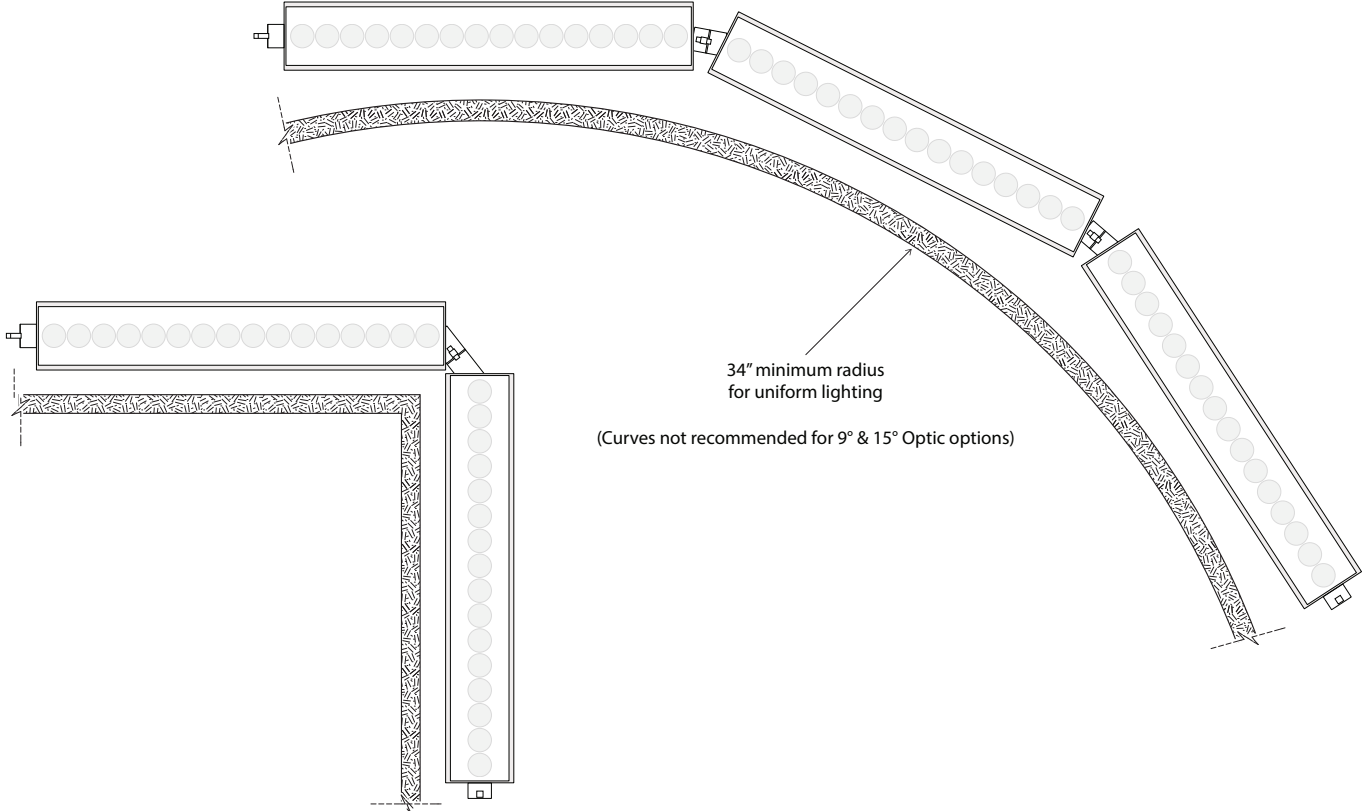
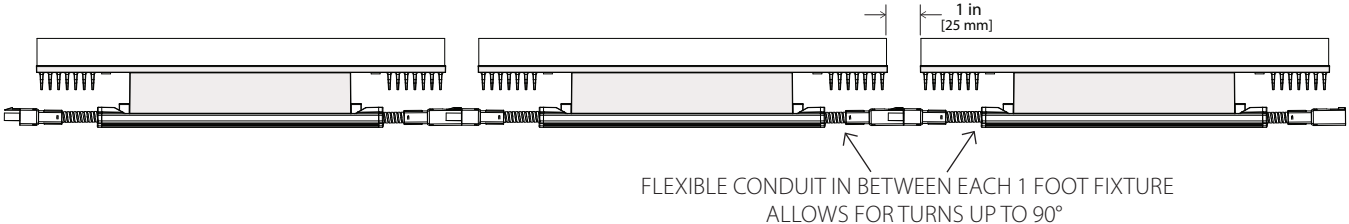

## LOUVERS

ASYMMETRICAL LOUVER (GS-C6C-A-BK)

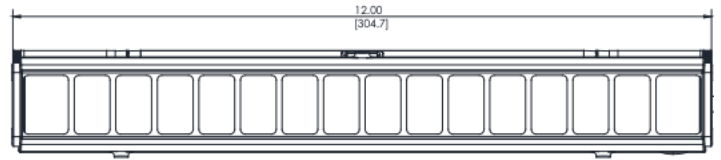
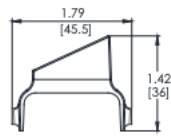

SYMMETRICAL LOUVER (GS-C6C-S-BK)

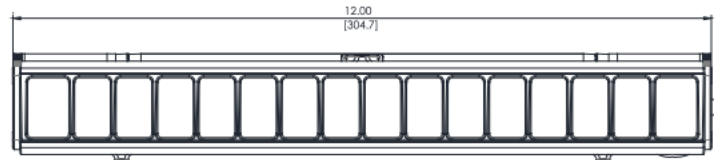
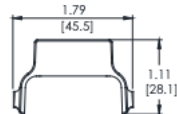

HONEYCOMB LOUVER (GS-C6C-H-BK)

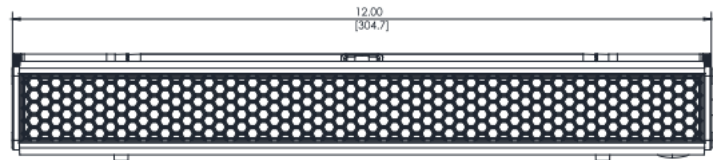
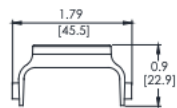

## MOUNTING HARDWARE

SURFACE MOUNT CLIP (C6A-MC)  
FOR UPLIGHT APPLICATIONS ONLY



2.0"(l) x 1.0"(w) x 0.2"(h)

INVERTED MOUNTING BRACKET (C6A-IMB)  
EXTRA SUPPORT FOR DOWN LIGHT & SIDE MOUNT APPLICATIONS

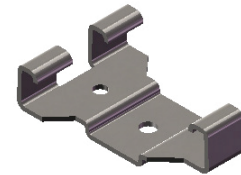

2.25"(l) x 1.6"(w) x 0.7"(h)

10° OR 20° ANGLE MOUNTING BRACKET (C6A-MTGBRKT-1020)

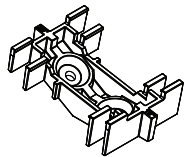
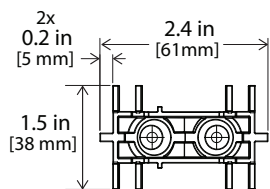

10° MOUNTING DETAIL

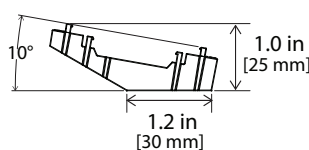

20° MOUNTING DETAIL

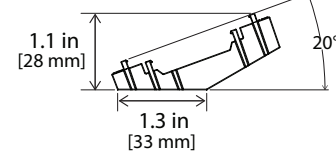

## MOUNTING HARDWARE

### 90° ADJUSTABLE MOUNTING BRACKET (PA-8)

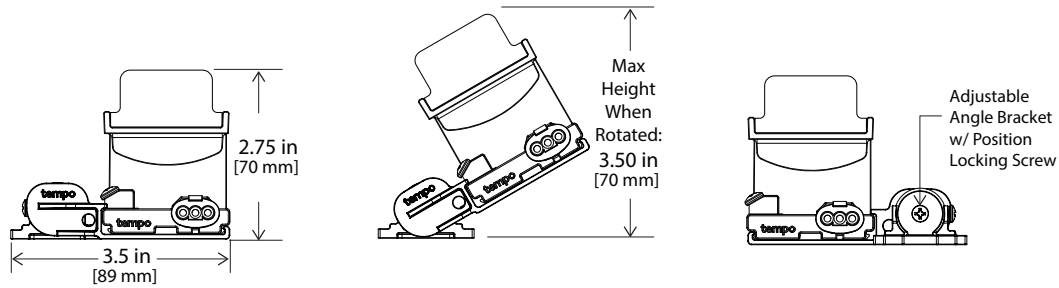

### 100° (50° L / 50° R) ROTATIONAL MOUNTING BRACKET (ROT-MTGBRK-C6/C6RX-NA)

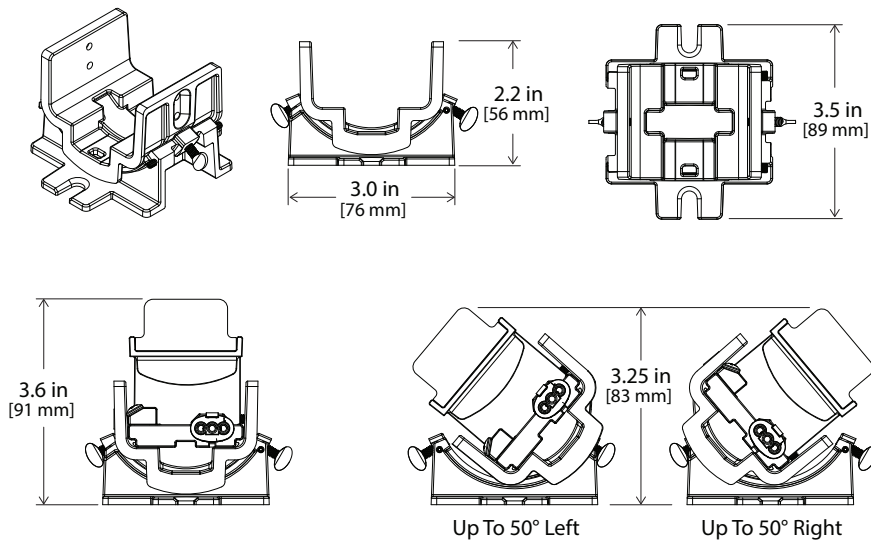

INSTALLATION GUIDELINES

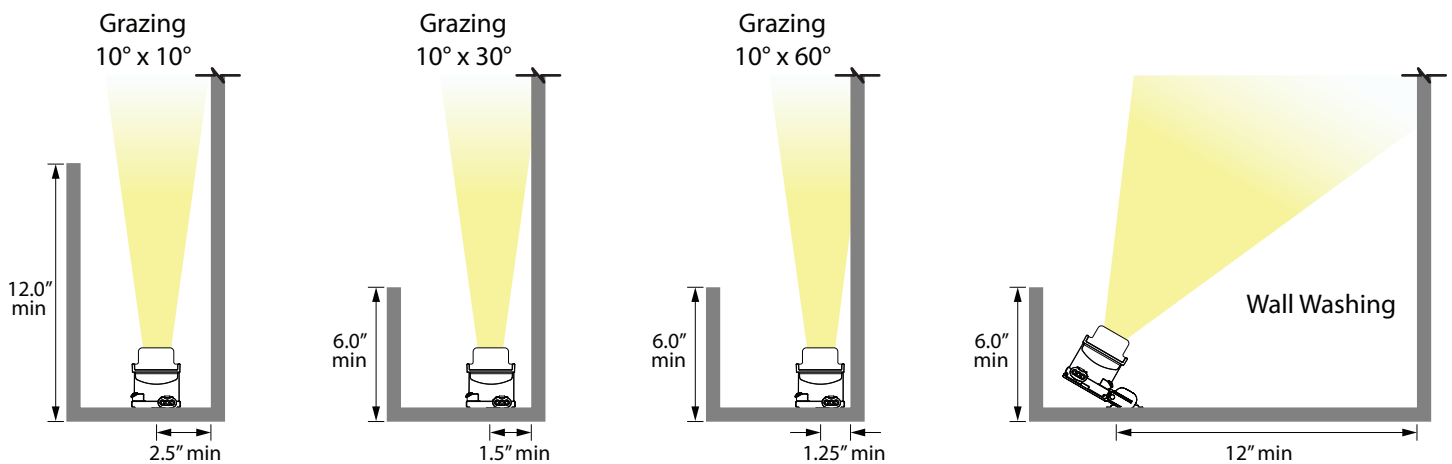

**WALL GRAZING**

10° wall graze optics are specifically designed to highlight rough architectural surfaces and textures such as stone and brick. The narrow optic will highlight raised features while creating shadows in recessed features. Do not graze smooth surfaces as the narrow optical distributions are not designed for this. Smooth surfaces require wall washing.

Graze fixtures should be mounted at least the set back distances called out in the diagrams above. Some surfaces with deep architectural details or textures may require even greater set back distances.

Above diagrams also call out the recessed depth which helps hide the fixtures and at same time optimize the consistency of illumination with reflective light inside the recessed area. If recessed area is bare wood or metal they tend to reflect the color of the wood or metal onto the illuminated surface with bad results. Therefore white base paint is recommended for interior of recessed area.

**WALL WASHING**

Wall washing is a lighting effect that eliminates shadows on a wall and enhances the smoothness of a wall. Also used to highlight architectural feature such as sculptures, wall hangings, and more. Washing is an easy way to create dramatic effects in any space and also makes the space feel larger by emphasizing vertical surfaces.

Set back distances will vary depending on the application and desired optic. The above diagram is general reference only and set back distances as much as 4 feet may be required for surfaces above 10 feet high. Aiming is essential part of wall washing and Tempo has multiple mounting options for aiming such as the all new 100° rotational mounting bracket (ROT-MTGBRK-C6/C6RX-NA).

### 10° x 10°

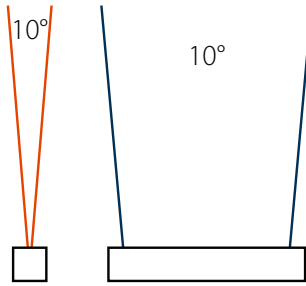

Polar Candela Distribution  
C6C; 3500K; 5W/ft; 10° x 10°

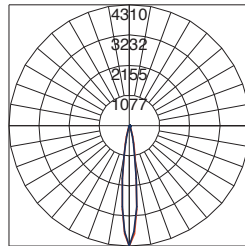

■ V Plane thru H Angles (0 - 180)  
■ V Plane thru H Angles (90 - 270)

Polar Candela Distribution  
C6C; 3500K; 9W/ft; 10° x 10°

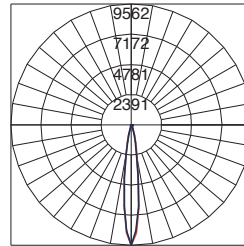

■ V Plane thru H Angles (0 - 180)  
■ V Plane thru H Angles (90 - 270)

Polar Candela Distribution  
C6C; 3500K; 12W/ft; 10° x 10°

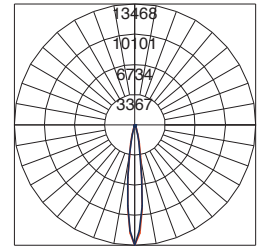

■ V Plane thru H Angles (0 - 180)  
■ V Plane thru H Angles (90 - 270)

### 10° x 30°

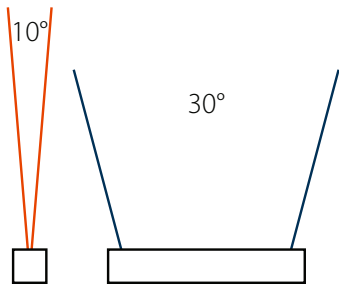

Polar Candela Distribution  
C6C; 3500K; 5W/ft; 10° x 30°

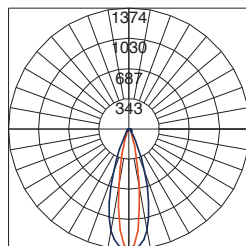

■ V Plane thru H Angles (0 - 180)  
■ V Plane thru H Angles (90 - 270)

Polar Candela Distribution  
C6C; 3500K; 9W/ft; 10° x 30°

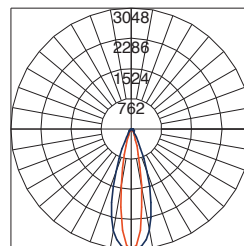

■ V Plane thru H Angles (0 - 180)  
■ V Plane thru H Angles (90 - 270)

Polar Candela Distribution  
C6C; 3500K; 12W/ft; 10° x 30°

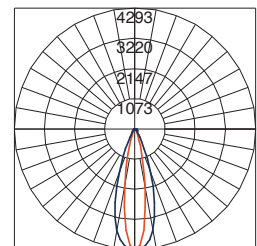

■ V Plane thru H Angles (0 - 180)  
■ V Plane thru H Angles (90 - 270)

### 10° x 60°

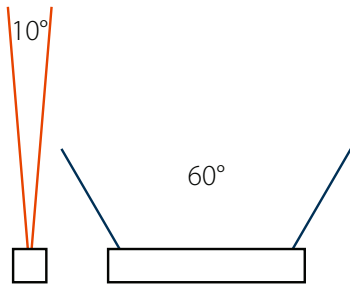

Polar Candela Distribution  
C6C; 3500K; 5W/ft; 10° x 60°

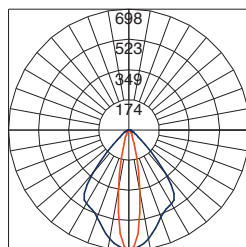

■ V Plane thru H Angles (0 - 180)  
■ V Plane thru H Angles (90 - 270)

Polar Candela Distribution  
C6C; 3500K; 9W/ft; 10° x 60°

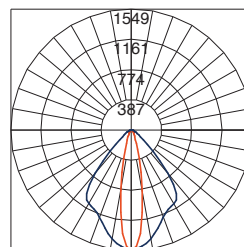

■ V Plane thru H Angles (0 - 180)  
■ V Plane thru H Angles (90 - 270)

Polar Candela Distribution  
C6C; 3500K; 12W/ft; 10° x 60°

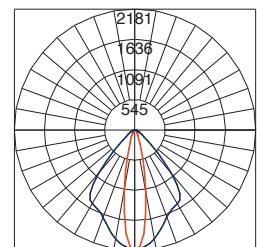

■ V Plane thru H Angles (0 - 180)  
■ V Plane thru H Angles (90 - 270)

### 15° x 35°

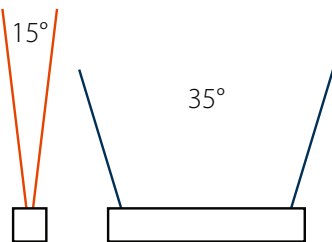

Polar Candela Distribution  
C6C; 3500K; 5W/ft; 15° x 35°

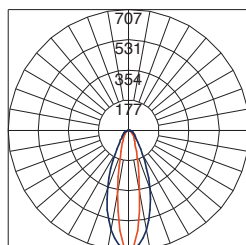

■ V Plane thru H Angles (0 - 180)  
■ V Plane thru H Angles (90 - 270)

Polar Candela Distribution  
C6C; 3500K; 9W/ft; 15° x 35°

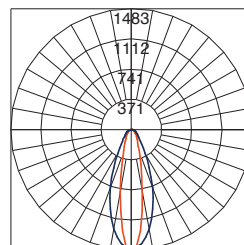

■ V Plane thru H Angles (0 - 180)  
■ V Plane thru H Angles (90 - 270)

Polar Candela Distribution  
C6C; 3500K; 12W/ft; 15° x 35°

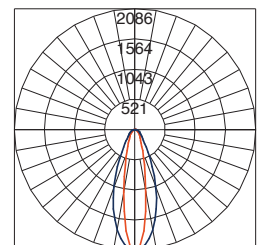

■ V Plane thru H Angles (0 - 180)  
■ V Plane thru H Angles (90 - 270)

### 25° x 25°

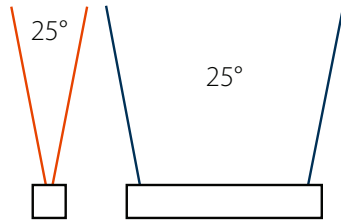

Polar Candela Distribution  
C6C; 3500K; 5W/ft; 25° x 25°

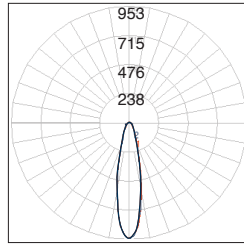

■ V Plane thru H Angles (0 - 180)  
■ V Plane thru H Angles (90 - 270)

Polar Candela Distribution  
C6C; 3500K; 9W/ft; 25° x 25°

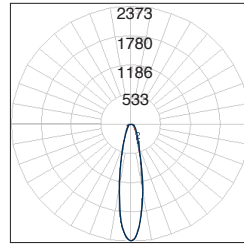

■ V Plane thru H Angles (0 - 180)  
■ V Plane thru H Angles (90 - 270)

Polar Candela Distribution  
C6C; 3500K; 12W/ft; 25° x 25°

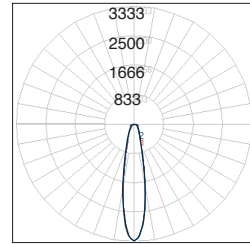

■ V Plane thru H Angles (0 - 180)  
■ V Plane thru H Angles (90 - 270)

### 25° x 45°

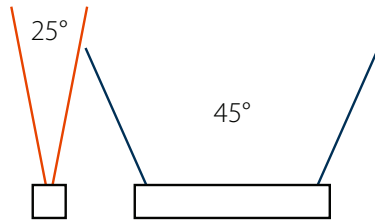

Polar Candela Distribution  
C6C; 3500K; 5W/ft; 25° x 45°

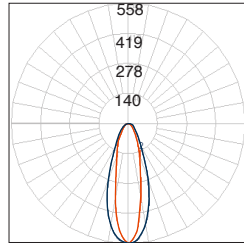

■ V Plane thru H Angles (0 - 180)  
■ V Plane thru H Angles (90 - 270)

Polar Candela Distribution  
C6C; 3500K; 9W/ft; 25° x 45°

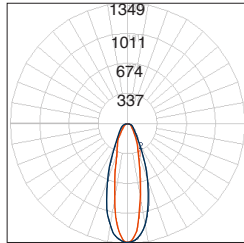

■ V Plane thru H Angles (0 - 180)  
■ V Plane thru H Angles (90 - 270)

Polar Candela Distribution  
C6C; 3500K; 12W/ft; 25° x 45°

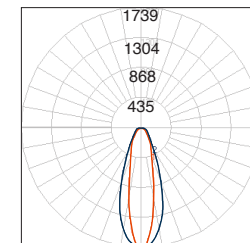

■ V Plane thru H Angles (0 - 180)  
■ V Plane thru H Angles (90 - 270)

### 25° x 75°

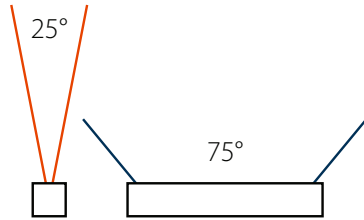

Polar Candela Distribution  
C6C; 3500K; 5W/ft; 25° x 75°

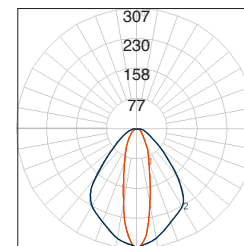

■ V Plane thru H Angles (0 - 180)  
■ V Plane thru H Angles (90 - 270)

Polar Candela Distribution  
C6C; 3500K; 9W/ft; 25° x 75°

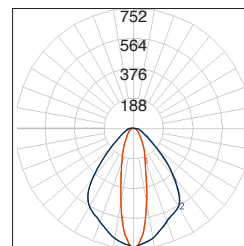

■ V Plane thru H Angles (0 - 180)  
■ V Plane thru H Angles (90 - 270)

Polar Candela Distribution  
C6C; 3500K; 12W/ft; 25° x 75°

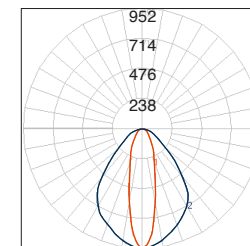

■ V Plane thru H Angles (0 - 180)  
■ V Plane thru H Angles (90 - 270)

### 40° x 60°

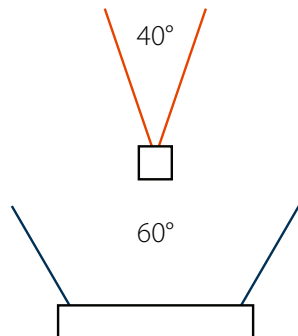

Polar Candela Distribution  
C6C; 3500K; 5W/ft; 40° x 60°

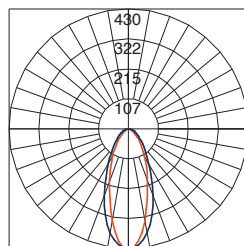

■ V Plane thru H Angles (0 - 180)  
■ V Plane thru H Angles (90 - 270)

Polar Candela Distribution  
C6C; 3500K; 9W/ft; 40° x 60°

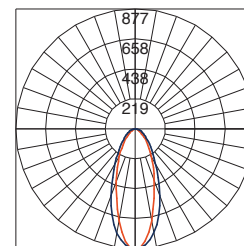

■ V Plane thru H Angles (0 - 180)  
■ V Plane thru H Angles (90 - 270)

Polar Candela Distribution  
C6C; 3500K; 12W/ft; 40° x 60°

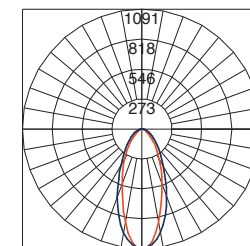

■ V Plane thru H Angles (0 - 180)  
■ V Plane thru H Angles (90 - 270)

55° x 25°

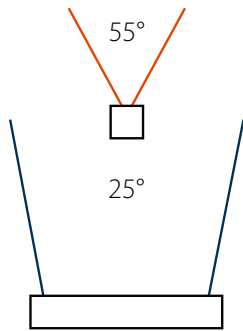

Polar Candela Distribution  
C6C; 3500K; 5W/ft; 55° x 25°

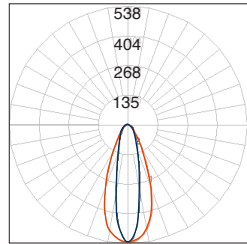

■ V Plane thru H Angles (0 - 180)  
■ V Plane thru H Angles (90 - 270)

Polar Candela Distribution  
C6C; 3500K; 9W/ft; 55° x 25°

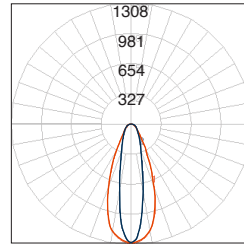

■ V Plane thru H Angles (0 - 180)  
■ V Plane thru H Angles (90 - 270)

Polar Candela Distribution  
C6C; 3500K; 12W/ft; 55° x 25°

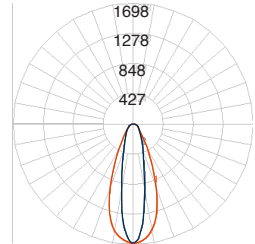

■ V Plane thru H Angles (0 - 180)  
■ V Plane thru H Angles (90 - 270)

120° x 120°

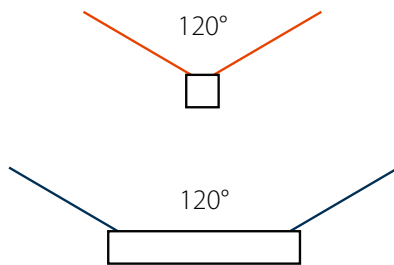

Polar Candela Distribution  
C6C; 3500K; 5W/ft; 120° x 120°

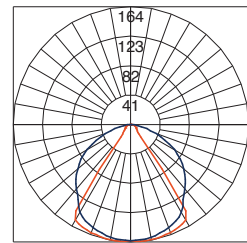

■ V Plane thru H Angles (0 - 180)  
■ V Plane thru H Angles (90 - 270)

Polar Candela Distribution  
C6C; 3500K; 9W/ft; 120° x 120°

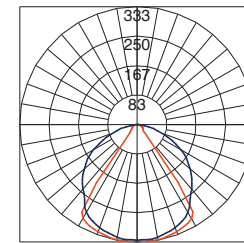

■ V Plane thru H Angles (0 - 180)  
■ V Plane thru H Angles (90 - 270)

Polar Candela Distribution  
C6C; 3500K; 12W/ft; 120° x 120°

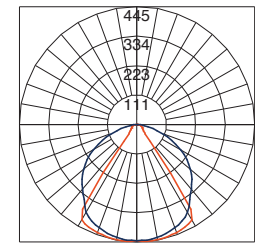

■ V Plane thru H Angles (0 - 180)  
■ V Plane thru H Angles (90 - 270)

