

Linear Series - Thin 1

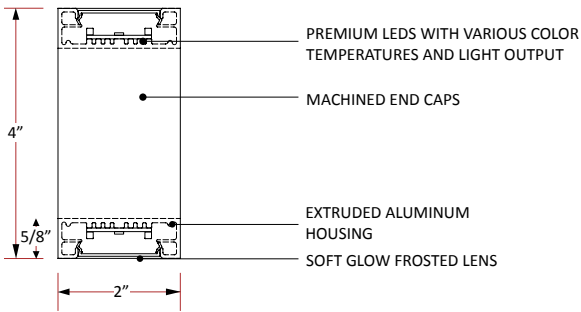

CABLE SUSPENDED (CS)

FEATURES:

- Powered Suspension System - No power cord
- High transmission frosted lenses with no diode imaging
- No visible fasteners
- Extruded aluminum housing
- Dimmable/Programmable drivers for controllable light output
- High efficacy LEDs with 5 year warranty
- Under 2 steps MacAdams Ellipse Binning
- 3/8" thick machined end caps
- 360° rotation option - with mechanical locking
- Bi-directional luminaire

NOTES:

- **REQUIRES REMOTE DRIVER(S)** (see page 5 for more info)

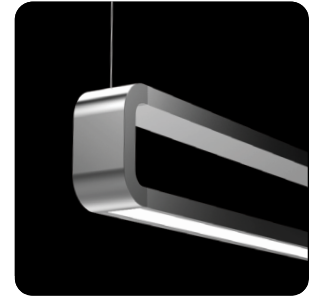

PRODUCT SPECIFICATION

NOTE: All options *italicized* may increase lead times and/or incur higher costs - please consult factory with questions.

FIXTURE TYPE	MOUNTING/ ORIENTATION	NOMINAL LENGTH*	COLOR TEMP	LED DRIVE POWER		VOLTAGE	DRIVER	HOUSING FINISH
				DIRECT	INDIRECT*			
LS-THN-1	CS Cable Suspended - BI-DIRECTIONAL	1' 1' 2' 2' 3' 3' 4' 4'	27K 2700K 30K 3000K 35K 3500K 40K 4000K 50K 5000K	VLO Very Low Output 378 lumens/ft. (4w/ft.)	VLO Very Low Output 378 lumens/ft. (4w/ft.)	UNV Universal (120-277v) 1V 120v 2V 227v 3V 347v*	ND Non-Dimming 0-10v DIMMING 10D 10% DIM 1D 1% DIM LUTRON LITEA Lutron Hi-Lume 1% (2-Wire) LDE1 Lutron EcoSystem 1% "Soft on" (Digital) LDES Lutron EcoSystem 5% 5-Series (Digital) DALI DALI Digital Addressable Lighting Interface	SC Satin Clear Anodize (Standard) SW Satin White (Powder Coat) MB Matte Black (Powder Coat) CF Custom Finish* (Consult Factory)
	CSD Cable Suspended - DIRECT ONLY	CR_ ' Continuous Run (Specify length in nominal feet)	LO Low Output 570 lumens/ft. (6w/ft.)	LO Low Output 570 lumens/ft. (6w/ft.)				
	CSV Cable Suspended - Vertical		SO Standard Output 748 lumens/ft. (8w/ft.)	SO Standard Output 748 lumens/ft. (8w/ft.)				
	CSR Cable Suspended - ROTATIONAL		HO High Output 935 lumens/ft. (10w/ft.)	HO High Output 935 lumens/ft. (10w/ft.)				
				VHO Very High Output 1,088 lumens/ft. (12w/ft.)	VHO Very High Output 1,088 lumens/ft. (12w/ft.)			
				CPO Custom Power Output Consult factory	CPO Custom Power Output Consult factory			

*Dimensions are for reference only. Contact factory for more specific information or shop drawings.
**Odd lengths may incur slightly higher per foot pricing.

*Not Applicable with CSD option. DIRECT ONLY

*Not all dimming options are available with 347v.

*RAL and color match are available.

HARDWARE* DETAIL FINISH	DRIVER HOUSING FINISH	CANOPY SIZE OPTIONS*	CANOPY FINISH	POWER CORD COLOR	AIRCRAFT CABLE LENGTH*	OPTIONS/ CUSTOMIZATION*
MF Machined Finish (Standard) SW Satin White MB Matte Black CF Custom Finish (Consult Factory)	MA Mill Aluminum* SC Satin Clear SW Satin White SB Satin Black CF Custom Finish (Consult Factory)	44 4" Power feed canopy 4" Non-power feed canopy	SW Satin White SB Satin Black MF Machine Finish CF Custom Finish (Consult Factory)	PSS Powerd Suspension System (No Power Cord) CC Custom Cord (Consult Factory)	2 2' 4 4' 6 6' 8 8' CL_ Custom Length** (Specify in feet IE: CL10 for 10')	XX No EMB or Customization EMB7 7 Watt battery back-up** (Approximately 600 lumens) EMB12 12 Watt battery back-up** (Approximately 1,000 lumens) 90 90+ CRI LED BOARDS CCP Corners/patterns* CD Custom Driver* CR Customization Requested*

NOTE: MF option is strongly recommended. Other options will result in higher costs and potentially longer lead times.
**Hardware* refers to the end caps and knuckles (knuckles only for the "Rotational" option).

*Most cost effective.

*See options section and installation instructions for more information.

*Cables are field adjustable.
** Consult factory to confirm specific length.

NOTE: Customization may incur higher costs and/or increased lead times.
*Consult the factory for all custom options or custom concept requests.
**The EMB12 is slightly more expensive than the EMB7 option (BOTH OPTIONS ARE REMOTE ONLY).

SPECIFICATION INFORMATION

GENERAL NOTES:

All fixtures are **UL listed** for **dry** and **damp** locations.

REMOTE DRIVER for all options.

Please contact the factory with any specification questions.

Italicized options may incur additional costs and/or extended lead times. Please consult the factory.

FIXTURE ORIENTATION:

Bidirectional (CS) for downlight and uplight applications.

Direct (CSD) for ONLY downlight applications.

Rotational (CSR) for adjustable applications: 360° rotational capacity with locking mechanism.

DRIVER: [REMOTE]

1) NON-DIMMING: As described... this fixture will not dim.

2) DIMMING: 0-10v: 1%, 10% :: Lutron: 2-wire Forward phase (Hi-Lume 1%), Ecosystem to 1% (Soft On), Ecosystem to 5% (5 Series). "DALI" - Specify driver. See "Dimming Options" on subsequent pages for more information. For other dimming options, consult the factory.

3) EMERGENCY: Specify EMB under the Options/Customization category at the end of the cut sheet along with the desired lumen output (600 or 1,000 lumens - the latter is slightly more costly).

4) Drivers are programmed according to our standard lumen packages or to custom watt/lumen package requirements.

5) Consult factory with any questions or specification requirements.

FINISHES:

The standard finish is a Satin Clear anodized housing with Machine Finished hardware. Machined finish is preferable for machined components (Hardware Detail) - Powder coating these parts may result in additional costs. Consult the factory with any questions about standard or custom finishing options.

CUSTOMIZATION:

We have numerous custom options available. However, if there is something unique required for a project, from simple options to complete custom requests, we are more than willing to entertain any creative notions you might have. Just ask.

Linear Series - Thin 1

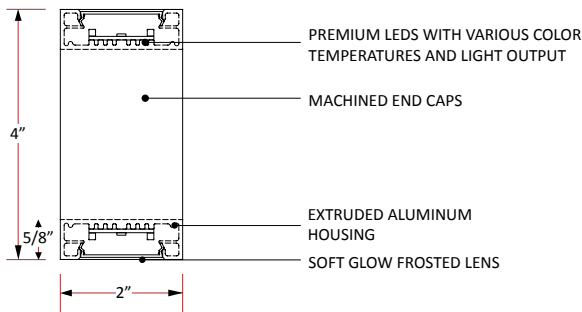

ROTATIONAL ARM MOUNT (RAM)

FEATURES:

- 5/8" diameter rigid tube mounting system
- High transmission frosted lenses with no diode imaging
- No visible fasteners
- Extruded aluminum housing
- Dimmable/Programmable drivers for controllable light output
- High efficacy LEDs with 5 year warranty
- Under 2 steps MacAdams Ellipse Binning
- 5/16" thick machined end caps
- Bi-directional fixture
- 360° rotation option- with mechanical locking

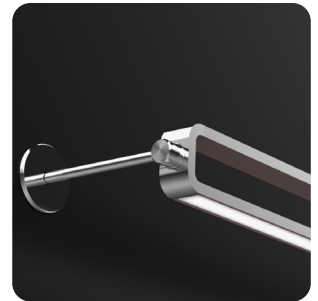

NOTES:

- **REQUIRES REMOTE DRIVER(S)** (see page 5 for more info)



PRODUCT SPECIFICATION

NOTE: All options *italicized* may increase lead times and/or incur higher costs - please consult factory with questions.

FIXTURE TYPE	MOUNTING/ ORIENTATION	NOMINAL LENGTH*	COLOR TEMP	LED DRIVE POWER		VOLTAGE	DRIVER	HOUSING FINISH
				DIRECT	INDIRECT*			
LS-THN-1	RAM Rotational Arm Mount	1' 1'	27K 2700K	VLO Very Low Output	VLO Very Low Output	UNV Universal (120-277v)	ND Non-Dimming 0-10v DIMMING	SC Satin Clear Anodize (Standard)
		2' 2'	30K 3000K	LO Low Output	LO Low Output			
		3' 3'	35K 3500K	SO Standard Output	SO Standard Output	1V 120v	10D 10% DIM	SW Satin White (Powder Coat)
		4' 4'	40K 4000K	HO High Output	HO High Output	2V 227v	1D 1% DIM	MB Matte Black (Powder Coat)
		CR Continuous Run (Specify length in nominal feet)	50K 5000K	VHO Very High Output	VHO Very High Output	3V 347v*	LTEA Lutron Hi-Lume 1% (2-Wire)	CF Custom Finish* (Consult Factory)
				CPO Custom Power Output Consult factory	CPO Custom Power Output Consult factory		LDE1 Lutron EcoSystem 1% "Soft on" (Digital)	
							LDE5 Lutron EcoSystem 5% 5-Series (Digital)	
							DALI Digital Addressable Lighting Interface	

*Dimensions are for reference only. Contact factory for more specific information or shop drawings.
**Odd lengths may incur slightly higher per foot pricing.

*Not Applicable with CSD option. DIRECT ONLY

*Not all dimming options are available with 347v.

*RAL and color match are available.

HARDWARE* DETAIL FINISH	DRIVER HOUSING FINISH	ARM LENGTH*	MOUNTING/ COVER PLATE	OPTIONS/ CUSTOMIZATION*
MF Machined Finish (Standard) CF Custom Finish (Consult Factory)	MA Mill Aluminum* SC Satin Clear SW Satin White SB Satin Black CF Custom Finish (Consult Factory)	3 3" 6 6" 9 9" 12 12" CAL Custom Length** (Specify in inches IE: CL10 for 10")	4CPF Flat 4" diameter Cover Plate - For use with a 3-O mud ring CCP Custom Cover Plate* (Consult factory)	XX No EMB or Customization EMB7 7 Watt battery back-up** (Approximately 600 lumens) EMB12 12 Watt battery back-up** (Approximately 1,000 lumens) 90 90+ CRI LED BOARDS CCP Corners/patterns* CD Custom Driver* CR Customization Requested*

NOTE: MF option is strongly recommended. Other options will result in higher costs and potentially longer lead times.
**"Hardware" refers to the end caps and knuckles (knuckles only for the "Rotational" option).

*Most cost effective.

*Arm length is measured from the mounting surface to the center of the fixture.
**Limitations apply. Consult the factory.

NOTE: Customization may incur higher costs and/or increased lead times.
*Consult the factory for all custom options or custom concept requests.
**The EMB12 is more expensive than the EMB7 option (BOTH OPTIONS ARE REMOTE ONLY).

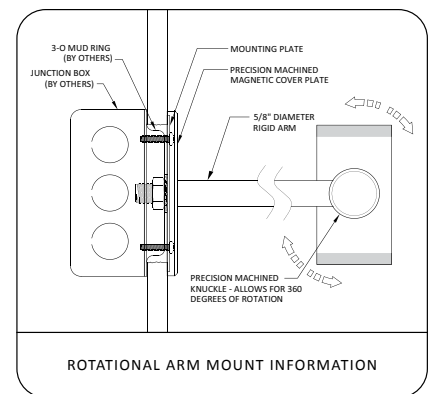

SPECIFICATION INFORMATION

GENERAL NOTES:

All fixtures are **UL listed** for **dry** and **damp** locations.
REMOTE DRIVER for all options.

Please contact the factory with any specification questions.

Italicized options may incur additional costs and/or extended lead times. Please consult the factory.

DRIVER: [REMOTE]

- 1) NON-DIMMING: As described... this fixture will not dim.
- 2) DIMMING: 0-10v: 1%, 10% :: Lutron: 2-wire Forward phase (Hi-Lume 1%, Ecosystem to 1% (Soft On), Ecosystem to 5% (5 Series). "DALI" - Specify driver. See "Dimming Options" on subsequent pages for more information. For other dimming options, consult the factory.
- 3) EMERGENCY: Specify EMB under the Options/Customization category at the end of the cut sheet along with the desired lumen output (600 or 1,000 lumens - the latter is slightly more costly).
- 4) Drivers are programmed according to our standard lumen packages or to custom watt/lumen package requirements.
- 5) Consult factory with any questions or specification requirements.

FINISHES:

The standard finish is a Satin Clear anodized housing with Machine Finished hardware. Machined finish is preferable for machined components (Hardware Detail) - Powder coating these parts may result in additional costs. Consult the factory with any questions about standard or custom finishing options.

CUSTOMIZATION:

We have numerous custom options available. However, if there is something unique required for a project, from simple options to complete custom requests, we are more than willing to entertain any creative notions you might have. Just ask.



Linear Series - Thin 1

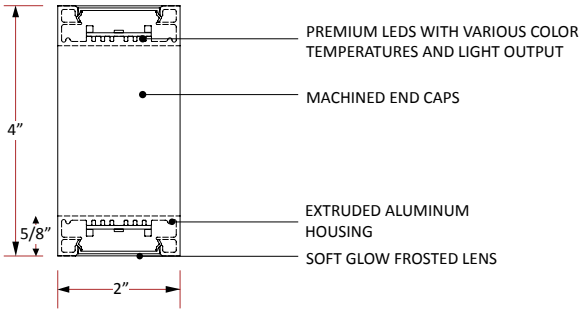

SURFACE MOUNT (SM)

FEATURES:

- Ceiling or wall mounting system
- High transmission frosted lenses with no diode imaging
- No visible fasteners
- Extruded aluminum housing
- Dimmable/Programmable drivers for controllable light output
- High efficacy LEDs with 5 year warranty
- Under 2 steps MacAdams Ellipse Binning
- 5/16" thick machined end caps
- Bi-directional fixture



NOTES:

- **REQUIRES REMOTE DRIVER(S)** (see page 5 for more info)

PRODUCT SPECIFICATION

NOTE: All options *italicized* may increase lead times and/or incur higher costs - please consult factory with questions.

FIXTURE TYPE	MOUNTING/ ORIENTATION	NOMINAL LENGTH*	COLOR TEMP	LED DRIVE POWER		VOLTAGE	DRIVER	HOUSING FINISH
				DIRECT	INDIRECT*			
LS-THN-1	SMS Surace Mount - SIDE	1' 1'	27K 2700K 30K 3000K 35K 3500K 40K 4000K 50K 5000K	VLO Very Low Output 378 lumens/ft. (4w/ft.)	VLO Very Low Output 378 lumens/ft. (4w/ft.)	UNV Universal (120-277v) 1V 120v 2V 227v 3V 347v*	ND Non-Dimming 0-10v DIMMING 10D 10% DIM 1D 1% DIM LUTRON LTEA Lutron Hi-Lume 1% (2-Wire) LDE1 Lutron EcoSystem 1% "Soft on" (Digital) LDES Lutron EcoSystem 5% 5-Series (Digital) DALI DALI Digital Addressable Lighting Interface	SC Satin Clear Anodize (Standard) SW Satin White (Powder Coat) MB Matte Black (Powder Coat) CF Custom Finish* (Consult Factory)
		2' 2' 3' 3' 4' 4' CR_ Continuous Run (Specify length in nominal feet)		LO Low Output 570 lumens/ft. (6w/ft.)	LO Low Output 570 lumens/ft. (6w/ft.)			
				SO Standard Output 748 lumens/ft. (8w/ft.)	SO Standard Output 748 lumens/ft. (8w/ft.)			
				HO High Output 935 lumens/ft. (10w/ft.)	HO High Output 935 lumens/ft. (10w/ft.)			
				VHO Very High Output 1,088 lumens/ft. (12w/ft.)	VHO Very High Output 1,088 lumens/ft. (12w/ft.)			
				CPO Custom Power Output Consult factory	CPO Custom Power Output Consult factory			

DRIVER HOUSING FINISH	HARDWARE* DETAIL FINISH	STAND OFF DISTANCE	OPTIONS/ CUSTOMIZATION*
MA Mill SC Aluminum* SW Satin Clear SB Satin White CF Satin Black Custom Finish (Consult Factory)	MF Machined Finish (Standard) CF Custom Finish (Consult Factory)	0 Flush .5 Half Inch 1 1" 3 3" 6 6" CU_ Custom (Specify in feet IE: CU4.5 for 4.5')	XX No EMB or Customization EMB7 7 Watt battery back-up** (Approximately 600 lumens) EMB12 12 Watt battery back-up** (Approximately 1,000 lumens) 90 90+ CRI LED BOARDS CCP Corners/patterns* CD Custom Driver* CR Customization Requested*
*Most cost effective.		NOTE: The MF option is strongly recommended. Other options will result in higher costs and potentially longer lead times. **"Hardware" refers to the end caps and knuckles (knuckles only for the "Rotational" option).	NOTE: Customization may incur higher costs and/or increased lead times. *Consult the factory for all custom options or custom concept requests. **The EMB12 is slightly more expensive than the EMB7 option (BOTH OPTIONS ARE REMOTE ONLY).

SPECIFICATION INFORMATION

GENERAL NOTES:

All fixtures are **UL listed** for **dry** and **damp** locations.

REMOTE DRIVER for all options.

Please contact the factory with any specification questions.

Italicized options may incur additional costs and/or extended lead times. Please consult the factory.

DRIVER: [REMOTE]

- 1) NON-DIMMING: As described... this fixture will not dim.
- 2) DIMMING: 0-10v: 1%, 10% :: Lutron: 2-wire Forward phase (Hi-Lume 1%), Ecosystem to 1% (Soft On), Ecosystem to 5% (5 Series). "DALI" - Specify driver. See "Dimming Options" on subsequent pages for more information. For other dimming options, consult the factory.
- 3) EMERGENCY: Specify EMB under the Options/Customization category at the end of the cut sheet along with the desired lumen output (600 or 1,000 lumens - the latter is slightly more costly).
- 4) Drivers are programmed according to our standard lumen packages or to custom watt/lumen package requirements.
- 5) Consult factory with any questions or specification requirements.

FINISHES:

The standard finish is a Satin Clear anodized housing with Machine Finished hardware. Machined finish is preferable for machined components (Hardware Detail) - Powder coating these parts may result in additional costs. Consult the factory with any questions about standard or custom finishing options.

CUSTOMIZATION:

We have numerous custom options available. However, if there is something unique required for a project, from simple options to complete custom requests, we are more than willing to entertain any creative notions you might have. Just ask.

Linear Series - Thin 1

PRODUCT SPECIFICATION

- Fixture delivered light potential: 95 Lumens/Watt*
- Uniform light distribution
- 90+ CRI LED diode options
- Exceptional binning- less than 2 step MacAdams Ellipse
- Minimum 70% initial lumen output at 70,000 hours
- Standard 0-10v dimming to %10
- Lutron, Eldoled, Dali, and other dimming options
- 5 year system warranty

*Actual fixture efficacy will be dependent on specification. Higher lumens per watt are achieved with lower drive powers. Please contact the factory with questions or for more information.

LUMEN OUTPUT*

DRIVER OUTPUT	LUMEN OUTPUT (PER FOOT)	
	WATTAGE	LUMENS
VERY LOW (VLO)	8	756
LOW (LO)	12	1,140
STANDARD (SO)	16	1,496
HIGH (HO)	20	1,870
VERY HIGH (VHO)	24	2,176

DRIVER OUTPUT	PER 4' FIXTURE (TOTAL DELIVERED LUMENS)	
	WATTAGE	LUMENS
VERY LOW (VLO)	32	3,024
LOW (LO)	48	4,560
STANDARD (SO)	64	5,984
HIGH (HO)	80	7,480
VERY HIGH (VHO)	96	8,704

- **VERY LOW:** Considerably underdrives the LEDs to maximize fixture efficacy potential and limit wattage use.
- **LOW:** Underdrives the LEDs for reasonable light output while maintaining low wattage use.
- **STANDARD:** Drives the LEDs for the best combination of lumen output and fixture efficacy.
- **HIGH:** Drive the LEDs at higher capacity for higher lumen output with good efficacy.
- **VERY HIGH:** Drives the LEDs at the highest capacity for the highest lumen output with the best efficacy.

*Lumen output will vary depending on ambient temperature. Cooler ambient and LED color temperatures result in higher luminaire performance. Calculations are based on 4000K LEDs.

FIXTURE ORIENTATION:
Direct (ESMD) for downlight applications.
Indirect (ESMI) for uplight applications.

LUMINOUS INTENSITY DISTRIBUTION

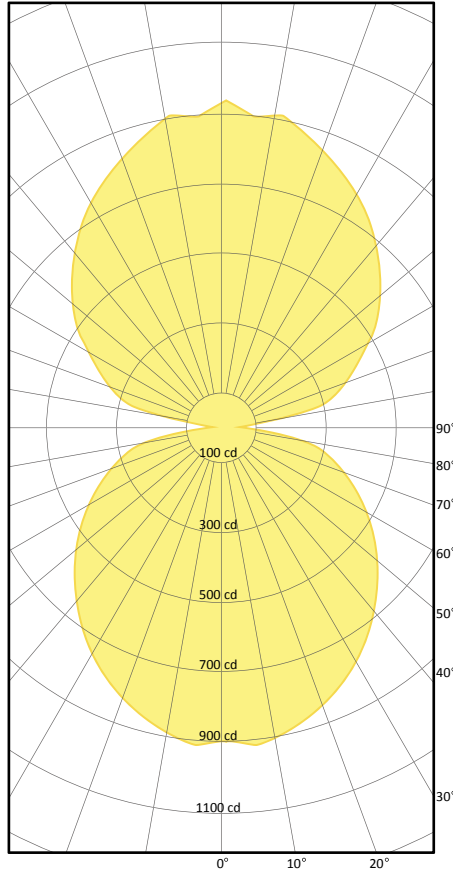

FIXTURE PROPERTIES (AS TESTED)

- 4' nominal length fixture
- Standard Output (SO)
- Total system energy consumption: 64 Watt
- 95 Lumens/Watt
- 4000K 80 CRI LED

ZONAL LUMEN SUMMARY

ZONE	LUMEN	%LAMP	%FIXTURE
0 - 30	703	8.1%	12.1%
0 - 40	1,154	13.4%	19.9%
0 - 60	2,108	24.4%	36.4%
0 - 90	2,987	34.6%	51.6%
90 - 120	881	10.2%	15.2%
90 - 150	2,285	26.5%	39.5%
90 - 180	2,986	34.6%	51.6%
0 - 180	5,974	69.2%	103.2%

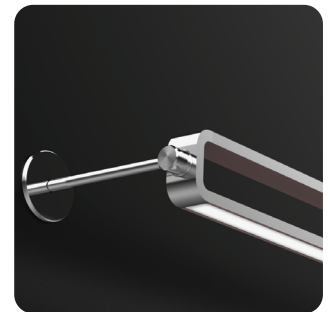
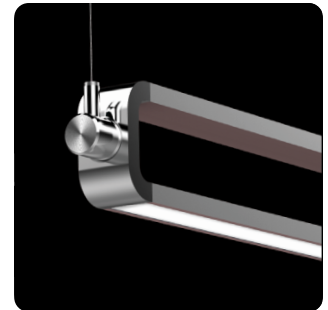
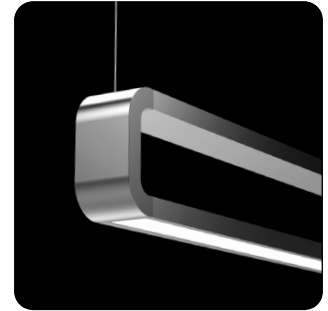

PROJECT _____

TYPE _____

Linear Series - Thin 1

REMOTE DRIVER HOUSING SIZES _____

The driver housing length is typically dictated by the options selected. Standard driver housing lengths are as shown. Non standard driver requests may increase or decrease the driver housing length. Specifications are subject to change without notice. Consult factory with questions, requests, or size limitations and we will do our best to accommodate your needs.

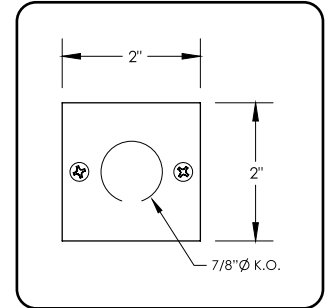
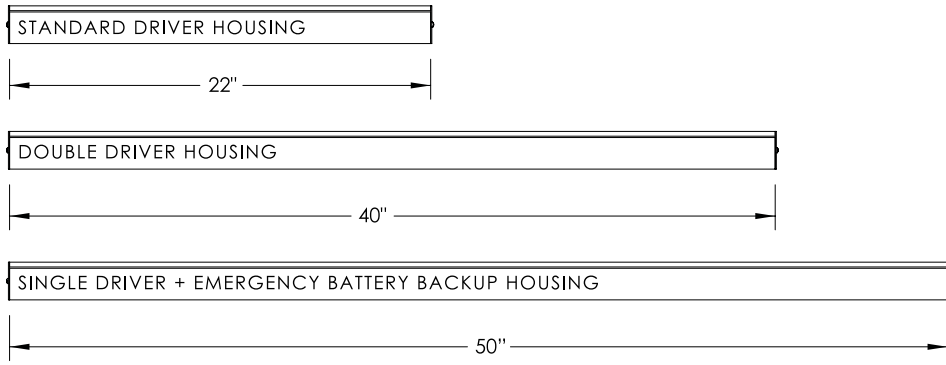

DRIVER HOUSING PROFILE

INSTRUCTIONS _____

See below for lid removal and installation instructions.

To remove the driver housing lid, use a broad slot screwdriver in the channel as shown here and twist the screwdriver ninety degrees. This may need to be done at both ends of the housing or multiple locations depending on the driver housing length.

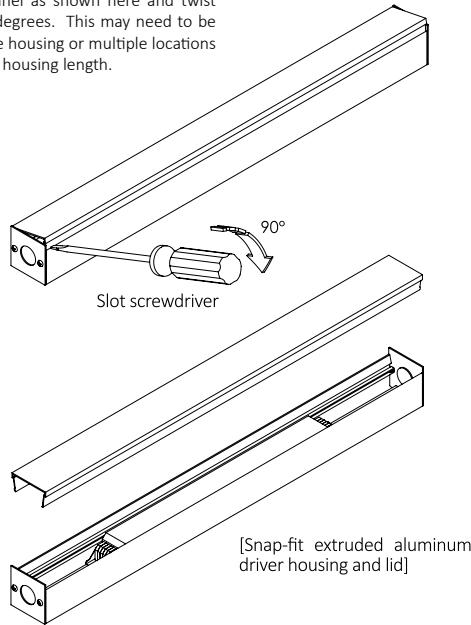

1) Drill mounting holes in the driver housing as needed to secure to a suitable surface. (If needed, a power feed hole can be drilled into the bottom of the housing for certain mounting/power feed applications).

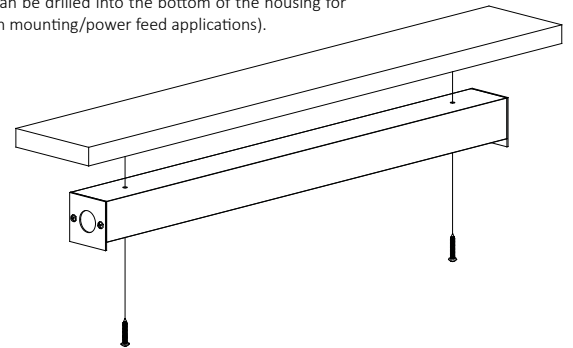

2) Secure the housing to the surface. (Fasteners by others)
3) Complete wire make-up.
4) Snap extruded lid onto the housing.

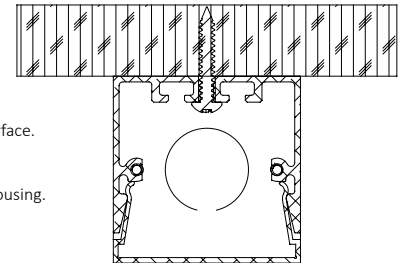

FINISHES _____

Mill Aluminum (MA) is the standard finish. Satin White and Satin Black powder coat and Satin Clear anodized finishes can be done for a small charge. Custom finishes are possible. Contact the factory for specific finish options, specific requests, RAL colors, or any other questions.



Mill Aluminum (MA)
[Standard Finish]

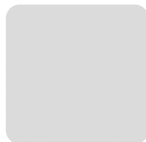

Satin White (SW)
[Upgrade Finish]



Satin Black (SB)
[Upgrade Finish]



Satin Clear (SC)
[Upgrade Finish]



Custom Finish (CF)
[Upgrade Finish]



Linear Series - Thin 1

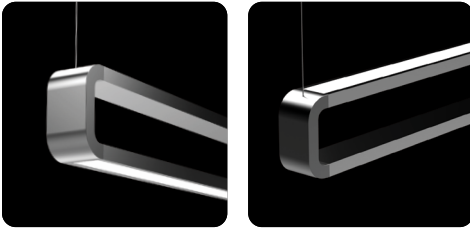

CABLE SUSPENDED (CS)

Powered Suspension System. Palladium 1 (Pd1) can be static down-light and up-light: Bi-Directional (CS), static down-light ONLY: Direct (CSD), or Rotational (see below). Standard and custom power cord finishes, sleeve options, and canopy colors offer options to match almost any space. Stainless steel cables come in various lengths (4' is standard) and are field adjustable.

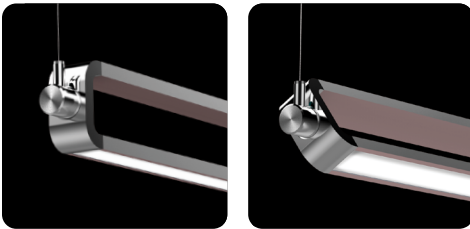

(360° ROTATION)

CABLE SUSPENDED ROTATIONAL (CS-R)

Using a similar setup to the Cable Suspended system above, the Cable Suspended - Rotational system has 360 degree rotational capacity with mechanical fasteners to lock fixtures in place if desired. This system offers incredible flexibility, light direction control, and a dynamic aesthetic.

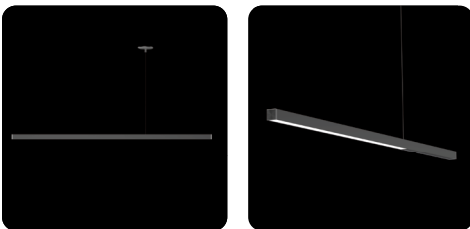

CABLE SUSPENDED VERTICAL (CSV)

Power Suspension System. Yttrium (Y) can be a static Bi-Directional light hung up-right (CSV). Standard and custom power cord finishes, sleeve options, and canopy colors offer options to match almost any space. Stainless steel cables come in various lengths (4' is standard) and are field adjustable.

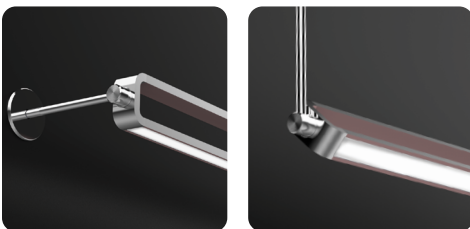

(360° ROTATION)

ROTATIONAL ARM MOUNT (RAM)

This system uses 5/8" diameter aluminum arms and subtle details in combination with a 360 degree rotational capacity to create some of the most versatile linear fixtures in the architectural market. Standard mounting uses 3-O mud rings (supplied by others) or a 1" optional trim ring for furniture mounted applications. Engineered with no visible fasteners, smooth rotation, and mechanical locking, the RAM system reveals an impressive aesthetic with exceptional versatility.



SURFACE MOUNT (SM)

Side Mount Side (SMS) or Side Mount Direct Only (SMSD). Side, the fixture is mounted on the wall giving a static bi-directional up-light and down-light. Direct Only, the fixture is mounted on the wall as well but only gives a static down-light.

Linear Series - Thin 1

CONTINUOUS RUN

Continuous runs are available with all fixtures and have several connection options. Single Seam continuous run options offer smooth section transitions while Component Seams lend to a more dramatic visual statement. The 360 Rotational option enables individual sections to rotate independently of each other, which offers adjustable asymmetric light distribution capacity along with striking appearances such as alternating up/down fixtures or spiral transitions. The flexibility within the rotational option makes for infinite design and functional possibilities.



CONTINUOUS RUN
SINGLE SEAM

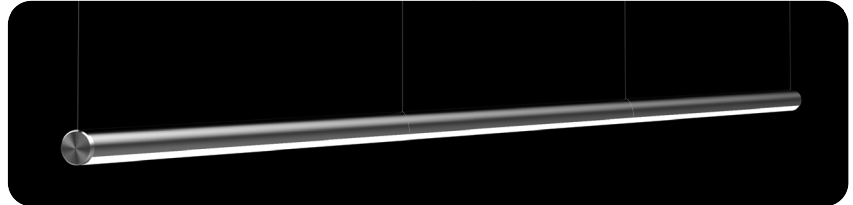

FIXTURE WITH A SINGLE SEAM CONTINUOUS RUN

CANOPIES

STANDARD

Canopies have several standard options to suit various environment aesthetics. The standard cable suspension system has 5" Satin White canopies. However, other standard options include a 2" non-power feed canopy option as well as no canopy at all. Both of these include a 5" diameter power feed canopy.

55

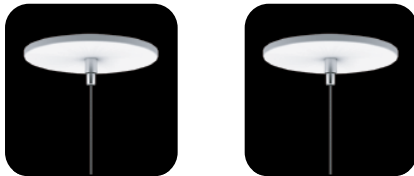

5" diameter power feed and 5" diameter non-pow feed canopy. Most common canopy layout. Creates a consistent ceiling aesthetic.

52



5" diameter power feed and 2" diameter non-power feed canopy. Offers a more minimal ceiling treatment while maintaining the ability to cover up mistakes. Requires a 1/4-20 stud securely fastened to the ceiling.

50



5" diameter power feed canopy and no canopy on the non-power feed side. Minimal aesthetic. Requires a 1/4-20 stud securely attached to ceiling. Works well with continuous runs where the power can be carried inside the fixture.

MACHINED

Machined canopies are 4" in diameter and can be anodized as well as powder coated to match a desired color or they can be left with a mill finish for a more striking look. Similar non-power feed options are available with this aesthetic as well. These options do carry a higher cost than standard canopies, but also have an impressive appearance.

44

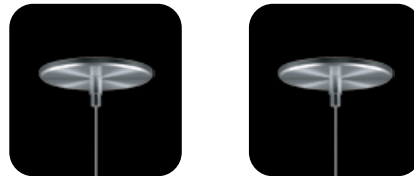

4" diameter machined power feed and 4" diameter machined non-power feed canopy. Offers a consistent ceiling aesthetic with smaller machined canopies. Mill, anodized, and powder coat finishes available.

41



4" diameter machined power feed and 1-1/4" diameter machined non-power feed canopy. Offers minimal ceiling treatment while maintaining the ability to cover mistakes. Requires a 1/4-20 stud securely fastened to the ceiling. Mill, anodized, and powder coat finishes available.

40



4" diameter machined power feed canopy and no canopy on the non-power feed side. Minimal aesthetic. Requires a 1/4-20 stud securely attached to the ceiling. Works well with continuous runs where the power can be carried inside the fixture. Mill, anodized, and powder coat finishes available.

CUSTOM

Custom canopy options are available and can look spectacular in certain applications. Contact the factory with all custom requests or with any questions.



CUSTOM POWDER COAT



CUSTOM ANODIZE



CUSTOM SHAPE

Linear Series - Thin 1

COLOR AND FINISH

Standard finish configurations are Satin Clear (SC) housing with Machined Finish (MF) machined components (end caps, knuckles, cover plates, etc.). The incredibly clean detail within all of the machined components lends to an incredibly high end aesthetic with two tone finish. Numerous custom anodizing and powder coated finishes are available as well. If you have a particular color/finish treatment in mind, please contact the factory and we will do our best to accommodate your project needs.

STANDARD



SATIN CLEAR
ANODIZING

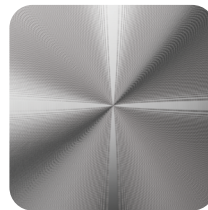

MACHINED
COMPONENTS

CUSTOM



MATTE BLACK



GLOSS BLACK



BRONZE



MILL ALUMINUM



SPECULAR



SATIN WHITE



GLOSS WHITE



COLOR POWDER COAT



COLOR ANODIZE



RAL COLORS

COVER PLATES

Cover plates are standard for Rotational Arm Mounting (RAM) Systems. Standard options are Flat (FT), Curved (CV), or Trim Ring (TR). With certain applications, cover plates or trim rings may not be necessary. Contact factory with questions or for more information. Custom cover plates are also available. If a certain aesthetic is desired, please contact the factory to review any concepts and we will do our best to bring your vision to life.

STANDARD

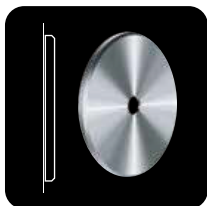

FLAT (CPFT)

Flat has a 4" diameter cover plate for use with a 3-O mud ring.

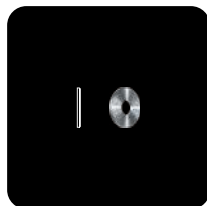

TRIM RING (TR)

1-1/4" diameter trim ring. Can be used in applications such as desk mounting.

CUSTOM

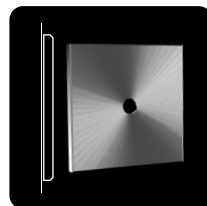

SQUARE

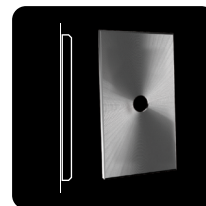

TALL RECTANGLE



CUSTOM