

Linear Series - Square 3

CABLE SUSPENDED

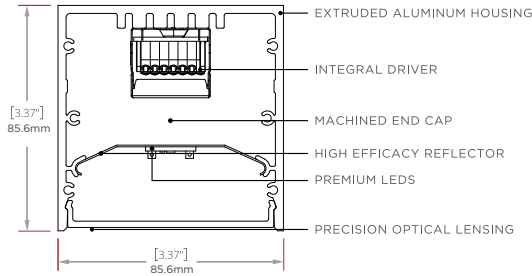

PERFORMANCE

STATIC WHITE | FLOOD DIRECT

POWER LEVELS	LIGHT DIRECT LM/4FT	TOTAL LIGHT LM/4FT	ENERGY WATTS/4FT	EFFICACY LPW	CCT/CRI
VL	1944	1944	16	121	4000/80
L	2725	2725	24	114	4000/80
S	3608	3608	32	113	4000/80
H	4341	4341	40	109	4000/80
VH	5236	5236	48	109	4000/80



FEATURES:

- PRECISION OPTICAL LENSING OPTIONS OR HIGH TRANSMISSION FROSTED LENSING
- 1% DIMMING DRIVERS STANDARD
- ADJUSTABLE AIRCRAFT CABLE SUSPENSION SYSTEM
- EXTRUDED ALUMINUM HOUSING WITH NO VISIBLE FASTENERS
- MACHINED ALUMINUM END CAPS WITH EASY ACCESS REMOVAL
- 360 DEGREE ROTATION OPTION WITH MECHANICAL LOCKING

CCT MULTIPLIERS STATIC WHITE

CCT	2700K		3000K		3500K		4000K		5000K	
CRI	80	90	80	90	80	90	80	90	80	90
MULTIPLIER	0.93	0.79	0.96	0.82	0.97	0.85	1	0.89	1.01	0.89

NOTE: ALL ITALICIZED OPTIONS MAY INCREASE LEAD TIME. PLEASE CONSULT FACTORY WITH QUESTIONS.

FIXTURE MODEL	MOUNTING	NOMINAL LENGTH (FT)	CCT/CRI	DIRECT		INDIRECT		DRIVER
				POWER LEVEL ¹	DIRECT BEAM DISTRIBUTION ¹	POWER LEVEL ¹	INDIRECT BEAM DISTRIBUTION ¹	
LS-SQU-3	CSD Cable Suspended Direct Only	2	827	VL Very low	G Graze	VL Very low	F Flood	1D 0-10V EldoLED 1% <i>01D</i> 0-10V EldoLED 0.1% <i>LDE1</i> Lutron Ecosystem 1% <i>LDE5</i> Lutron Ecosystem 5% <i>1DT</i> (TW) ² <i>1DW</i> (WD) ² <i>DMX8</i> Standard 8 bit (RGBW) ³ <i>DMX16</i> Optional 16 bit (RGBW) ³ <i>DALI</i> (INTL) <i>TWS</i> (Sensor Fixtures) ³
		3	830	L Low	N Narrow	L Low		
	CSI Cable Suspended Indirect	4	835	S Standard	F Flood	S Standard		
		5	840	H High	F Flood	H High		
	CSR Cable Suspended Rotational	6	850	VH Very High	W Wall Wash	VH Very High		
		7	927		A Aisle			
		8	930					
		<i>CP</i> ^{3,4} Custom Pattern	935					
		CR ^{1,2} Continuous Run (Specify Length in Nominal Feet)	940					
			950					
		<i>TW2765</i> <i>WD1827</i> <i>RGBW</i> ¹						
		¹ Power Feed is always at the first section in a continuous run ² Rotational mounting w/CR will have a power feed for every section ³ See final page for CP specifications guide ⁴ Finish must be powdercoated	¹ Pair only w/ power level(s) = S; beams = F	¹ Select only 'Direct' attributes for CSR & CSD mountings	¹ Select only 'Indirect' attributes for CSI mounting	¹ Driver must reside in remote housing ² 0-10V input - CHOOSE DALI instead for INTL versions ³ Integrated Sensor options pair with TWS driver only		

HOUSING FINISH	END CAPS FINISH ¹	CANOPY SIZE	CANOPY FINISH	POWER CORD	CABLE LENGTH	OPTIONS ⁵
SC Satin Clear Anodize SW Satin White Powder Coat MB Matte Black Powder Coat <i>CF</i> Custom Finish (Consult Factory)	MF Machined Finish SW Satin White MB Matte Black CF Custom Finish (Consult Factory)	44 4" Power feed canopy 4" Non-power feed canopy 44E 4" Power feed canopy 4" Non-power feed canopy - International 40 4" Power feed canopy Canopy only at power feed 40E 4" Power feed canopy Canopy only at power feed 41 4" Power feed canopy 1" Non-power feed canopy 41E 4" Power feed canopy 1" Non-power feed canopy - International	MF Machine Finish SW Satin White MB Matte Black CF Custom Finish (Consult Factory)	W White B Black G Gray ¹	4 4' 8 8'	EMB7 ^{1,3,4,5,6} 7 Watt battery back-up (Approximately 600 lumens) EMB12 ^{1,3,4,5,6} 12 Watt battery back-up (Approximately 1000 lumens) EMW ^{1,2} Emergency Circuit Wiring <i>WSN</i> ⁵ WSN nLight sensor <i>WSE</i> ⁵ WSE Enlighted Sensor <i>WSW</i> ⁵ WSW Wavelinx Sensor <i>WSL</i> ⁵ WSL Lutron Vive Sensor
	¹ CSR rotational hardware finish matches end cap finish selection			¹ Not available for INTL.		¹ EMB/EMW only linked to first section of continuous run ² EMW not available for 2ft/3ft lengths ³ EMB7 & EMB12 - 5ft lengths and up ⁴ CSI mounting not compatible with EMB ⁵ EMB not available for combined 8FT length & VH power ⁶ Factory EMB and Sensor (WS) options not avail for INTL

GENERAL NOTES:

All fixtures are UL listed for dry and damp locations. Fixtures with International (E) option designation are CE and ROHS compliant. INTEGRAL DRIVER for all options. Please contact the factory with any specification questions.



FIXTURE ORIENTATION

Direct (CSD) for downlight applications
 Indirect (CSI) for up light applications
 Rotational (CSR) for adjustable applications: 360 degree rotational capacity with locking mechanism.

Linear Series - Square 3

ROTATIONAL ARM MOUNT

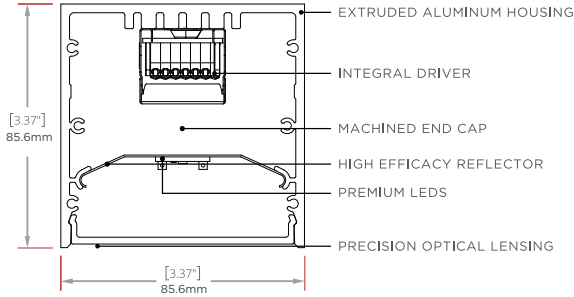

FEATURES:

- 3/4" DIAMETER RIGID TUBE MOUNTING SYSTEM
- PRECISION OPTICAL LENSING OPTIONS OR HIGH TRANSMISSION FROSTED LENSING
- 1% DIMMING DRIVERS STANDARD
- EXTRUDED ALUMINUM HOUSING WITH NO VISIBLE FASTENERS
- MACHINED ALUMINUM END CAPS WITH EASY ACCESS REMOVAL
- 360 DEGREE ROTATION OPTION WITH MECHANICAL LOCKING

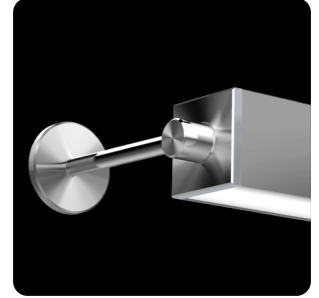

NOTE: ALL ITALICIZED OPTIONS MAY INCREASE LEAD TIME. PLEASE CONSULT FACTORY WITH QUESTIONS.

FIXTURE MODEL	MOUNTING	NOMINAL LENGTH (FT)	CCT/CRI	DIRECT POWER LEVEL	DIRECT BEAM DISTRIBUTION	DRIVER	HOUSING FINISH	
LS-SQU-3	RAM Rotational Arm Mount <i>RAME</i> Rotational Arm Mount - International	2	827 830 835 840 850 927 930 935 940 950 <i>TW2765</i> <i>WD1827</i> <i>RGBW¹</i>	VL Very low L Low S Standard H High VH Very High	G Graze N Narrow F Flood W Wall Wash A Aisle	1D 0-10V EldoLED 1% <i>01D</i> 0-10V EldoLED 0.1% <i>LDE1</i> Lutron Ecosystem 1% <i>LDE5</i> Lutron Ecosystem 5% <i>1DT</i> (TW) ² <i>1DW</i> (WD) ² <i>DMX8</i> Standard 8 bit (RGBW) ¹ <i>DMX16</i> Optional 16 bit (RGBW) ¹ <i>DALI</i> (INTL) <i>TWS</i> (Sensor Fixtures) ³	SC Satin Clear Anodize SW Satin White Powder Coat MB Matte Black Powder Coat CF Custom Finish (Consult Factory)	
		3						
		4						
		5						
		6						
		7						
		8						
		CR ^{1,2} Continuous Run (Specify Length in Nominal Feet)						
		1. Power feed is always at the first section in a continuous run 2. Rotational mounting w/ CR will have a power feed for every section						
		1. Pair only w/ power level(s) = S, beams = F						
1. Driver must reside in remote housing 2. 0-10V input - CHOOSE DALI instead for INTL versions 3. Integrated Sensor options pair with TWS driver only								

END CAPS & RAM HARDWARE FINISH	ARM LENGTH NOM (IN)	MOUNTING PLATE	OPTIONS ⁶
MF Machined Finish SW Satin White MB Matte Black <i>CF</i> Custom Finish (Consult Factory)	3 6¹ 9¹ 12¹	4CPF	EMB7^{1,3,5,6} 7 Watt battery back-up (Approximately 600 lumens) EMB12^{1,3,5,6} 12 Watt battery back-up (Approximately 1000 lumens) EMW^{1,2} Emergency Circuit Wiring <i>WSN⁶</i> WSN nLight sensor <i>WSE⁶</i> WSE Enlighted Sensor <i>WSW⁶</i> WSW Wavelength Sensor <i>WSL⁶</i> WSL Lutron Vive Sensor
1. Includes Mounting Tieback			1. EMB/EMW only linked to first section of continuous run 2. EMW not available for 2ft/3ft lengths 3. EMB7 & EMB12 - 5ft lengths and up 5. EMB not available for combined 8ft length & VH power 6. Factory EMB and Sensor (WS) options not avail for INTL

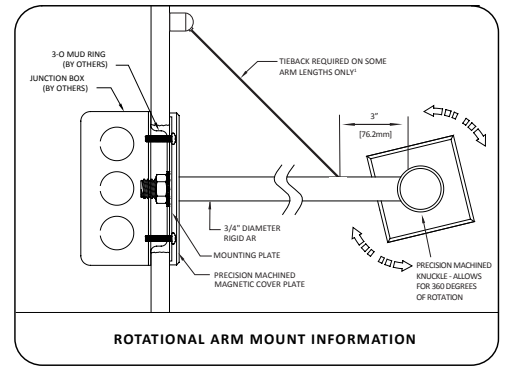

GENERAL NOTES:

All fixtures are UL listed for dry and damp locations. Fixtures with International (E) option designation are CE and ROHS compliant. INTEGRAL DRIVER for all options. Please contact the factory with any specification questions.



Linear Series - Square 3

SURFACE MOUNT

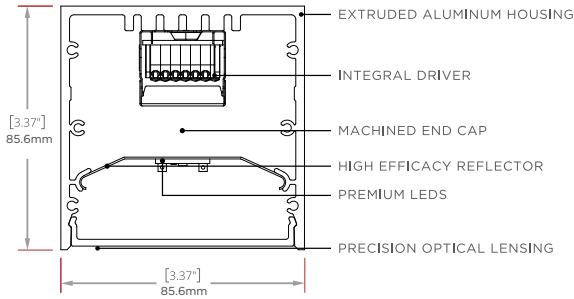

FEATURES:

- WALL MOUNTING SYSTEM
- PRECISION OPTICAL LENSING OPTIONS OR HIGH TRANSMISSION FROSTED LENSING
- 1% DIMMING DRIVERS STANDARD
- PRE LOCATED FIXTURE HARDWARE FOR EASY SURFACE INSTALL
- EXTRUDED ALUMINUM HOUSING WITH NO VISIBLE FASTENERS
- MACHINED ALUMINUM END CAPS WITH EASY ACCESS REMOVAL



NOTE: ALL ITALICIZED OPTIONS MAY INCREASE LEAD TIME. PLEASE CONSULT FACTORY WITH QUESTIONS.

FIXTURE MODEL	MOUNTING	NOMINAL LENGTH (FT)	CCT/CRI	DIRECT POWER LEVEL	DIRECT BEAM DISTRIBUTION	DRIVER	HOUSING FINISH
LS-SQU-3	SMS Surface Mount Side <i>SMSE</i> Surface Mount Side - International	2 3 4 5 6 7 8 CR ¹ Continuous Run (Specify Length in Nominal Feet)	827 830 835 840 850 927 930 935 940 950 <i>TW2765</i> <i>WD1827</i> <i>RGBW¹</i>	VL Very low L Low S Standard H High VH Very High	G Graze N Narrow Flood F Flood W Wall Wash A Aisle	1D 0-10V EldoLED 1% 01D 0-10V EldoLED 0.1% <i>LDE1</i> Lutron Ecosystem 1% <i>LDES</i> Lutron Ecosystem 5% 1DT (TW) ² 1DW (WD) ² DMX8 Standard 8 bit (RGBW) ¹ DMX16 Optional 16 bit (RGBW) ¹ DALI (INTL) TWS (Sensor Fixtures) ³	SC Satin Clear Anodize SW Satin White Powder Coat MB Matte Black Powder Coat CF Custom Finish (Consult Factory)
		1. Power feed is always first section of a continuous run	1. Pair only w/ power level(s) = S, beams = F			1. Driver must reside in remote housing 2. 0-10V input - CHOOSE DALI instead for INTL versions 3. Integrated Sensor options pair with TWS driver only	

END CAPS FINISH	OPTIONS ⁶
MF Machined Finish SW Satin White MB Matte Black CF Custom Finish (Consult Factory)	EMB7 ^{1,3,5,6} 7 Watt battery back-up (Approximately 600 lumens) EMB12 ^{1,3,5,6} 12 Watt battery back-up (Approximately 1000 lumens) EMW ^{1,2} Emergency Circuit Wiring WSN ⁶ WSN nLight sensor WSE ⁶ WSE Enlighted Sensor WSW ⁶ WSW Wavelinx Sensor WSL ⁶ WSL Lutron Vive Sensor
	1. EMB/EMW only linked to first section of continuous run 2. EMB/W not available for 2ft/3ft lengths 3. EMB7 & EMB12 - 5ft lengths and up 5. EMB not available for combined 8FT length & VH power 6. Factory EMB and Sensor (WS) options not avail for INTL

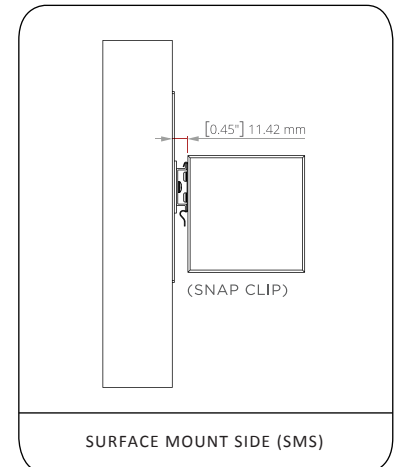

GENERAL NOTES:

All fixtures are UL listed for dry and damp locations. Fixtures with International (E) option designation are CE and ROHS compliant. INTEGRAL DRIVER for all options. Please contact the factory with any specification questions.



Linear Series - Square 3

DIRECT

STATIC WHITE | FLOOD DIRECT

POWER LEVELS	LIGHT DIRECT LM/4FT	TOTAL LIGHT LM/4FT	ENERGY WATTS/4FT	EFFICACY LPW	CCT/CRI
VL	1944	1944	16	121	4000/80
L	2725	2725	24	114	4000/80
S	3608	3608	32	113	4000/80
H	4341	4341	40	109	4000/80
VH	5236	5236	48	109	4000/80

CCT MULTIPLIERS, STATIC WH

CCT	80CRI	90CRI
2700K	0.93	0.79
3000K	0.96	0.82
3500K	0.97	0.85
4000K	1.00	0.89
5000K	1.01	0.89

DYNAMIC WHITE | FLOOD DIRECT

POWER LEVELS	LIGHT DIRECT LM/4FT	TOTAL LIGHT LM/4FT	ENERGY WATTS/4FT	EFFICACY LPW	CCT/CRI
VL	1364	1364	24	57	4000/90
L	1913	1913	32	60	4000/90
S	2532	2532	36	70	4000/90
H	3047	3047	44	69	4000/90
VH	3675	3675	48	77	4000/90

CCT MULTIPLIERS, DYNAMIC WH

CCT	90CRI
2700K	1.09
3000K	1.08
3500K	1.03
4000K	1.00
5000K	0.99
6500K	0.98

WARM DIM | FLOOD DIRECT

POWER LEVELS	LIGHT DIRECT LM/4FT	TOTAL LIGHT LM/4FT	ENERGY WATTS/4FT	EFFICACY LPW	CCT/CRI
VL	1432	1432	24	60	2700/90
L	2008	2008	32	63	2700/90
S	2658	2658	36	74	2700/90
H	3199	3199	44	73	2700/90
VH	3858	3858	48	80	2700/90

CCT MULTIPLIERS, WARM DIM

CCT	90CRI
1800K	0.02
2250K	0.17
2700K	1.00

RGBW | FLOOD DIRECT

POWER LEVELS	CHANNEL (S)	LIGHT DIRECT LM/4FT	TOTAL LIGHT LM/4FT	ENERGY WATTS/4FT	EFFICACY LPW	CCT
S	White	351.3	351	10	35	4000
S	All	811.9	812	20	41	N/A

Linear Series - Square 3

DIRECT

DIRECT OPTICS: LUMEN OUTPUT (PER 4FT)

TYPE	CCT/CRI	ENERGY WATTS/4FT	FLOOD LM/4FT	FLOOD LPW	NARROW FLOOD LM/4FT	NARROW FLOOD LPW	AISLE LIGHTER LM/4FT	AISLE LIGHTER LPW	GRAZE LM/4FT	GRAZE LPW	WALL WASH LM/4FT	WALL WASH LPW
STATIC WHITE	4000K/80	S (32W)	3608	113	4049	127	4203	131	4393	137	3958	124
DYNAMIC WHITE	4000K/90	S (36W)	2532	70	2865	80	2965	82	3098	86	2799	78
WARM DIM	2700K/90	S (36W)	2658	74	3008	84	3113	86	3253	90	2938	82
RGBW	ALL CHANNELS UP	S (20W)	812	41	N/A	N/A	N/A	N/A	N/A	N/A	N/A	N/A

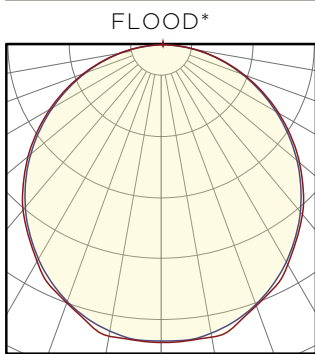

FLOOD*
MAX CANDELA: 1244
DELIVERED LUMENS: 3608
WATTS: 32
LPW: 113

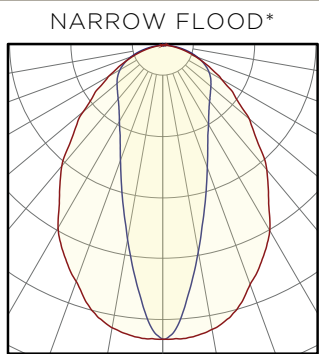

NARROW FLOOD*
MAX CANDELA: 2851
DELIVERED LUMENS: 4049
WATTS: 32
LPW: 127

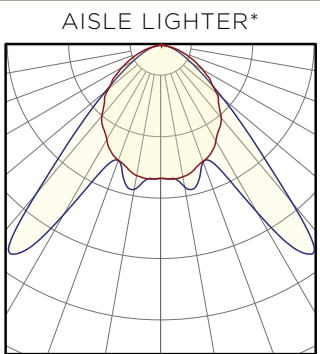

AISLE LIGHTER*
MAX CANDELA: 2565
DELIVERED LUMENS: 4203
WATTS: 32
LPW: 131

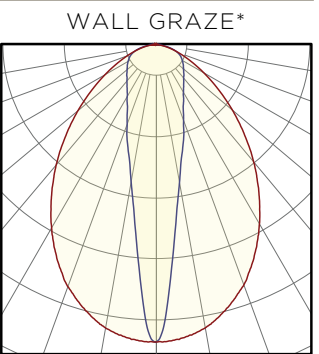

WALL GRAZE*
MAX CANDELA: 4185
DELIVERED LUMENS: 4393
WATTS: 32
LPW: 137

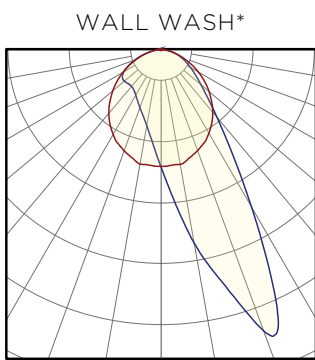

WALL WASH*
MAX CANDELA: 3729
DELIVERED LUMENS: 3958
WATTS: 32
LPW: 124

CCT MULTIPLIERS STATIC WHITE

CCT	2700K		3000K		3500K		4000K		5000K	
CRI	80	90	80	90	80	90	80	90	80	90
MULTIPLIER	0.93	0.79	0.96	0.82	0.97	0.85	1	0.89	1.01	0.89

CCT MULTIPLIERS DYNAMIC WHITE

CCT	2700K	3000K	3500K	4000K	5000K	6000K
CRI	90	90	90	90	90	90
MULTIPLIER	1.09	1.08	1.03	1	0.99	0.98

CCT MULTIPLIERS WARM DIM

CCT	1800K	2250K	2700K
CRI	90	90	90
MULTIPLIER	0.02	0.17	1

POWER LEVEL MULTIPLIERS

POWER	VL	L	S	H	VH
STATIC WHITE	0.53	0.75	1	1.2	1.45
DYNAMIC WHITE	0.53	0.75	1	1.2	1.45
WARM DIM	0.53	0.75	1	1.2	1.45

*Fixture Properties: 4ft Nominal Length, Standard Output, Static White 4000K/80CRI

Linear Series - Square 3

MOUNTING



CABLE SUSPENDED DIRECT (CSD) CABLE SUSPENDED INDIRECT (CSI)

This fixture can be a static down-light: Direct (CSD) or static up-light: Indirect (CSI). Aircraft cables come in 4ft and 8ft lengths and are field adjustable.



SURFACE MOUNT SIDE (SMS)

Surface Mount Side (SMS): the fixture is mounted on the wall & gives a static down-light.



CABLE SUSPENDED - ROTATIONAL (CSR)

Using a similar setup to the Cable Suspended system above, the Cable Suspended - Rotational system has 360 degree rotational capacity with mechanical fasteners to lock fixtures in place if desired. This system offers incredible flexibility, light direction control, and a dynamic aesthetic.

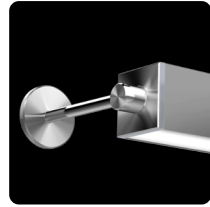

ROTATIONAL ARM MOUNT (RAM)

This system uses 5/8" diameter aluminum arms and subtle details in combination with a 360 degree rotational capacity to create some of the most versatile linear fixtures in the architectural market. Standard mounting uses 3/0 mud rings (supplied by others). Engineered with no visible fasteners, smooth rotation, and mechanical locking, the RAM system reveals an impressive aesthetic with exceptional versatility.

CONTINUOUS RUN (CR)

This fixture has two continuous run connection options. Our single seam continuous run option offers smooth transitions from one section to the next. The joiner bracket and alignment pin system in this option, offers easy to use, confident, single seam connections with a tight fit.

Alternatively, our 360 degree rotational option enables individual sections to rotate independently of each other, which offers adjustable asymmetric light distribution capacity along with striking appearances such as alternating up/down fixtures or spiral transitions. The flexibility within the rotational option makes for infinite design and functional possibilities.

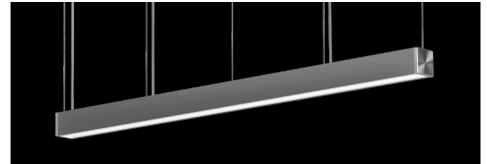

FIXTURE WITH SINGLE SEAM CONTINUOUS RUN



CONTINUOUS RUN ROTATIONAL



CONTINUOUS RUN ROTATIONAL
(SPIRAL EFFECT)



CONTINUOUS RUN
SINGLE SEAM



FIXTURE WITH CONTINUOUS RUN ROTATIONAL

CANOPIES

44



4" diameter power feed and 4" diameter non-power feed canopy.

40



4" diameter machined power feed canopy and no canopy on the non-power feed side. Minimal aesthetic. Requires a 1/4-20 stud securely attached to the ceiling.

41



4" diameter machined power feed and 1-1/4" diameter machined non-power feed canopy. Offers minimal ceiling treatment while maintaining the ability to cover mistakes. Requires a 1/4-20 stud securely fastened to the ceiling.

44E, 41E, 40E (**E) International Canopy



INTL POWERFEED CANOPY FOR
INTEGRAL DRIVER FIXTURES

This canopy replaces the flat style canopy from the North American mounting style (44, 41, & 40) versions pictured)

Linear Series - Square 3

COLOR AND FINISH

Standard luminaire housing finishes are Satin Clear anodized, Matte Black powder coat, and Satin White powder coat. Standard hardware (end caps, knuckles, cover plates, etc.) finishes are Machined Finish, Matte Black powder coat, & Satin White powder coat. Custom anodizing and powder coated finishes are available as well. If you have a particular color/finish treatment in mind, please contact the factory and we will do our best to accommodate your project needs.

LUMINAIRE



SATIN CLEAR ANODIZING

STANDARD



MATTE BLACK



SATIN WHITE

CUSTOM



BRONZE



COLOR ANODIZE



SPECULAR



RAL COLORS

HARDWARE

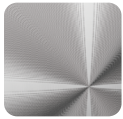

MACHINED COMPONENTS



MATTE BLACK



SATIN WHITE

SENSORS

Optional fixture integrated sensors and controls offer wireless control system compatibility directly from the factory. Tempo luminaires are now available with integrated control gear from 4 major partners.

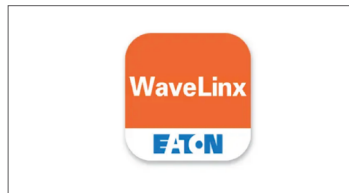

Linear Series - Square 3

WELDED CORNERS

- Luminaire housing is custom mitered & welded for a clean corner appearance
- Lens is also mitered for lens-to-lens interfaces that mirror the mitered housing
- Lens is illuminated to the corner (AKA: lit corners)
- Adjustable aircraft cable suspension system
- High quality powder coated finish (anodized finishes not available with welded custom patterns).

CUSTOMER INSTRUCTIONS

A. Select "CP" option in the ordering block (found in the NOMINAL LENGTH column)

B. Submit simple drawing(s) with the following info:

- Provide number of legs of pattern
- Length of each leg (A, B, C, D, etc)
- Angles of corners (a1, b1, c1, d1, etc)

1. For '3 dimensional' patterns, please provide side view(s) with desired angles, in addition to a top view.

2. Minimum corner angle is 30 degrees.



CUSTOM PATTERN PICTURED

EXAMPLES:

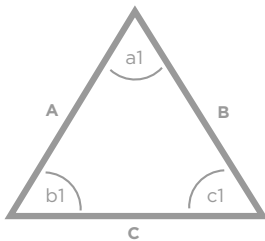

Customer Specification

1. Qty Legs = 3
2. A, B, C = 3ft
3. a1, b1, c1 = 60 deg

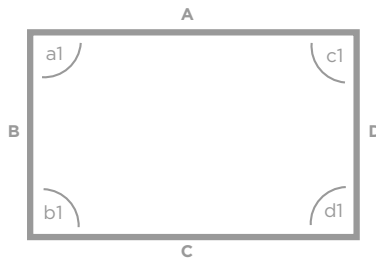

Customer Specification

1. Qty Legs = 4
2. A & C = 8ft, B & D = 4ft
3. a1, b1, c1, d1 = 90 deg

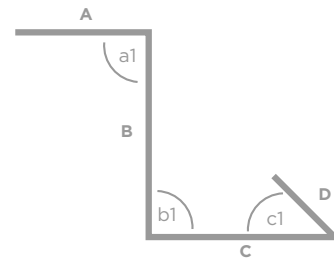

Customer Specification

1. Qty Legs = 4
2. A = 8ft, B = 6ft, C = 6ft, D = 4ft-3in
3. a1 & b1 = 90 deg, c1 = 45 deg