

Linear Series - Square 1

CABLE SUSPENDED

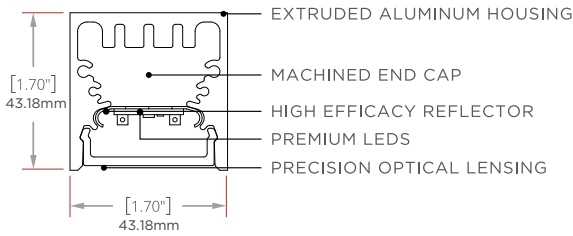

PERFORMANCE

STATIC WHITE | FLOOD DIRECT

POWER LEVELS	LIGHT DIRECT LM/4FT	TOTAL LIGHT LM/4FT	ENERGY WATTS/4FT	EFFICACY LPW	CCT/CRI
VL	1983	1983	16	124	4000/80
L	2780	2780	24	116	4000/80
S	3680	3680	32	115	4000/80
H	4428	4428	40	111	4000/80
VH	5342	5342	48	111	4000/80



FEATURES:

- POWERED SUSPENSION SYSTEM - NO SEPARATE POWER CORD DROP
- PRECISION OPTICAL LENSING OPTIONS OR HIGH TRANSMISSION FROSTED LENSING
- 1% DIMMING DRIVERS STANDARD
- EXTRUDED ALUMINUM HOUSING WITH NO VISIBLE FASTENERS
- MACHINED ALUMINUM END CAPS WITH EASY ACCESS REMOVAL
- 360 DEGREE ROTATION OPTION WITH MECHANICAL LOCKING

CCT MULTIPLIERS STATIC WHITE

CCT	2700K		3000K		3500K		4000K		5000K	
CRI	80	90	80	90	80	90	80	90	80	90
MULTIPLIER	0.93	0.79	0.96	0.82	0.97	0.85	1	0.89	1.01	0.89

NOTE: ALL ITALICIZED OPTIONS MAY INCREASE LEAD TIME. PLEASE CONSULT FACTORY WITH QUESTIONS.

FIXTURE MODEL	MOUNTING	NOMINAL LENGTH (FT)	CCT/CRI	DIRECT POWER LEVEL ¹	DIRECT BEAM DISTRIBUTION ¹	INDIRECT POWER LEVEL ¹	INDIRECT BEAM DISTRIBUTION ¹	DRIVER
LS-SQU-1	CSD Cable Suspended Direct Only	2	827	VL Very low	G Graze	VL Very low	F Flood	1D 0-10V EldoLED 1% 01D 0-10V EldoLED 0.1% LDE1 Lutron Ecosystem 1% LDE5 Lutron Ecosystem 5% 1DT (TW) ² 1DW (WD) ² DMX8 Standard 8 bit (RGBW) [*] DMX16 Optional 16 bit (RGBW) [*] (INTL) 1. Driver must reside in remote housing 2. 0-10V input - CHOOSE DALI instead for INTL versions
		3	830	L Low	N Narrow	L Low		
	CSI Cable Suspended Indirect	4	835	S Standard	F Flood	S Standard		
		5	840	H High	F Flood	H High		
	CSR Cable Suspended Rotational	6	850	VH² Very High	W Wall Wash	VH² Very High		
		7	927		A Aisle			
		8	930					
		<i>CP^{3,4}</i> Custom Pattern	935					
		CR^{1,3} Continuous Run (Specify Length in Nominal Feet)	940	TW2765				
			950	WD1827				
		RGBW¹						

HOUSING FINISH	END CAPS FINISH ¹	DRIVER HOUSING FINISH	CANOPY SIZE	CANOPY FINISH	POWER CORD	CABLE LENGTH	OPTIONS ⁶
SC Satin Clear Anodize SW Satin White Powder Coat MB Matte Black Powder Coat CF Custom Finish (Consult Factory)	MF Machined Finish SW Satin White MB Matte Black CF Custom Finish (Consult Factory)	SC Satin Clear SW Satin White MB Matte Black	44 4" Power feed canopy 4" Non-power feed canopy 44E 4" Power feed canopy 4" Non-power feed canopy - International 40 4" Power feed canopy Canopy only at power feed 40E 4" Power feed canopy Canopy only at power feed - International 41 4" Power feed canopy 1" Non-power feed canopy 41E 4" Power feed canopy 1" Non-power feed canopy - International	MF Machine Finish SW Satin White MB Matte Black CF Custom Finish (Consult Factory)	PSS	4 4' 8 8'	EMB7^{1,5,6} 7 Watt battery back-up (Approximately 600 lumens) EMB12^{1,5,6} 12 Watt battery back-up (Approximately 1000 lumens) EMW¹ Emergency Circuit Wiring 1. EMB/EMW only linked to first section of continuous run 5. EMB not available for combined 8FT length & VH power 6. Factory EMB and Sensor (WS ⁷) options not avail for INTL

GENERAL NOTES:

All fixtures are UL listed for dry and damp locations. Fixtures with International (E) option designation are CE and ROHS compliant. REMOTE DRIVER for all options. Please contact the factory with any specification questions.



FIXTURE ORIENTATION

Direct (CSD) for downlight applications
 Indirect (CSI) for up light applications
 Rotational (CSR) for adjustable applications: 360 degree rotational capacity with locking mechanism.

Linear Series - Square 1 ROTATIONAL ARM MOUNT

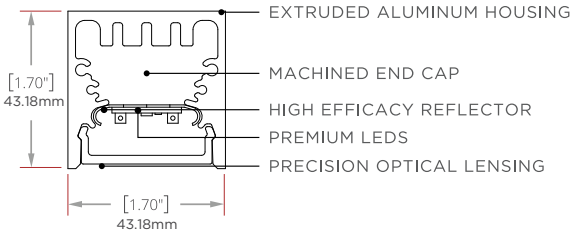

FEATURES:

- 5/8" DIAMETER RIGID TUBE MOUNTING SYSTEM
- PRECISION OPTICAL LENSING OPTIONS OR HIGH TRANSMISSION FROSTED LENSING
- 1% DIMMING DRIVERS STANDARD
- EXTRUDED ALUMINUM HOUSING WITH NO VISIBLE FASTENERS
- MACHINED ALUMINUM END CAPS WITH EASY ACCESS REMOVAL
- 360 DEGREE ROTATION OPTION WITH MECHANICAL LOCKING

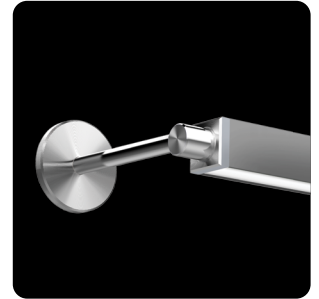

NOTE: ALL ITALICIZED OPTIONS MAY INCREASE LEAD TIME. PLEASE CONSULT FACTORY WITH QUESTIONS.

FIXTURE MODEL	MOUNTING	NOMINAL LENGTH (FT)	CCT/CRI	DIRECT POWER LEVEL	DIRECT BEAM DISTRIBUTION	DRIVER	HOUSING FINISH
LS-SQU-1	RAM Rotational Arm Mount	2	827	VL Very low	G Graze	1D 0-10V EldoLED 1%	SC Satin Clear Anodize SW Satin White Powder Coat MB Matte Black Powder Coat CF Custom Finish (Consult Factory)
	RAME Rotational Arm Mount - International	3	830	L Low	N Narrow	01D 0-10V EldoLED 0.1%	
		4	835	S Standard	F Flood	LDE1 Lutron Ecosystem 1%	
		5	840	H High	W Wall Wash	LDE5 Lutron Ecosystem 5%	
		6	850	VH² Very High	A Aisle	1DT (TW)²	
		7	927			1DW (WD)²	
		8	930			DMX8 Standard 8 bit (RGBW)*	
		CR^{1,3} Continuous Run (Specify Length in Nominal Feet)	935			DMX16 Optional 16 bit (RGBW)*	
			940			DALI (INTL)	
		950					
	<i>TW2765</i>						
	<i>WD1827</i>						
	<i>RGBW¹</i>						
	1. Power feed is always at the first section in a continuous run						
	3. Rotational mounting w/ CR will have a power feed for every section						
			<i>TW2765</i>				
			<i>WD1827</i>				
			<i>RGBW¹</i>				
			1. Pair only w/ power level(s) = S, beams = F				
						1. Driver must reside in remote housing	
						2. 0-10V input - CHOOSE DALI instead for INTL versions	

END CAPS & RAM HARDWARE FINISH	DRIVER HOUSING FINISH	ARM LENGTH NOM (IN)	MOUNTING PLATE	OPTIONS ⁶
MF Machined Finish SW Satin White MB Matte Black CF Custom Finish (Consult Factory)	SC Satin Clear SW Satin White MB Matte Black	3 6 9¹ 12¹	4CPF	EMB7^{1,2,6} 7 Watt battery back-up (Approximately 600 lumens) EMB12^{1,2,6} 12 Watt battery back-up (Approximately 1000 lumens) EMW¹ Emergency Circuit Wiring
		1. Includes Mounting Tieback		1. EMB/EMW only linked to first section of continuous run 2. EMB not available for combined 8FT length & VH power 6. Factory EMB and Sensor (WS*) options not avail for INTL

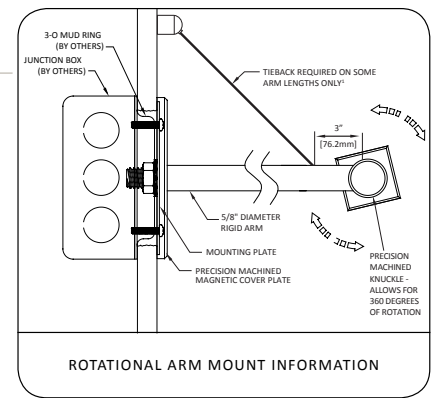

GENERAL NOTES:

All fixtures are UL listed for dry and damp locations. Fixtures with International (E) option designation are CE and ROHS compliant. REMOTE DRIVER for all options. Please contact the factory with any specification questions.



Linear Series - Square 1

SURFACE MOUNT

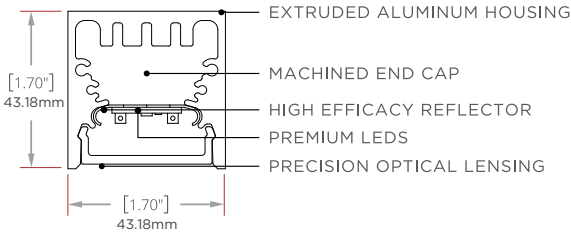

FEATURES:

- WALL MOUNTING SYSTEM
- PRECISION OPTICAL LENSING OPTIONS OR HIGH TRANSMISSION FROSTED LENSING
- 1% DIMMING DRIVERS STANDARD
- PRE LOCATED FIXTURE HARDWARE FOR EASY SURFACE INSTALL
- EXTRUDED ALUMINUM HOUSING WITH NO VISIBLE FASTENERS
- MACHINED ALUMINUM END CAPS WITH EASY ACCESS REMOVAL



NOTE: ALL ITALICIZED OPTIONS MAY INCREASE LEAD TIME. PLEASE CONSULT FACTORY WITH QUESTIONS.

FIXTURE MODEL	MOUNTING	NOMINAL LENGTH (FT)	CCT/CRI	DIRECT POWER LEVEL	DIRECT BEAM DISTRIBUTION	DRIVER	HOUSING FINISH
LS-SQU-1	SMS Surface Mount Side	2	827	VL Very low	G Graze	1D 0-10V EldoLED 1%	SC Satin Clear Anodize SW Satin White Powder Coat MB Matte Black Powder Coat CF Custom Finish (Consult Factory)
	SMSE Surface Mount Side - International	3	830	L Low	N Narrow	01D 0-10V EldoLED 0.1%	
		4	835	S Standard	F Flood	LDE1 Lutron Ecosystem 1%	
	SMTD Surface Mount Top (drywall)	5	840	H High	F Flood	LDE5 Lutron Ecosystem 5%	
	SMTB Surface Mount Top (TBAR) ¹	6	850	VH² Very High	W Wall Wash	1DT (TW) ²	
		7	927		A Aisle	1DW (WD) ²	
	SMTDE Surface Mount Top INTL (Drywall)	8	930			DMX8 Standard 8 bit (RGBW)*	
	SMTBE Surface Mount Top INTL (TBAR) ¹		935			DMX16 Optional 16 bit (RGBW)*	
		940			DALI (INTL)		
		950					
		<i>TW2765</i>					
		<i>WD1827</i>					
		<i>RGBW¹</i>					

1. Pair only w/ power level(s) = S, beams = F

2. VH not available for 8ft

1. Driver must reside in remote housing
2. 0-10V input - CHOOSE DALI instead for INTL versions

END CAPS FINISH	DRIVER HOUSING FINISH
MF Machined Finish	SC Machined Finish
SW Satin White	SW Satin Clear
MB Matte Black	MB Satin White
CF Custom Finish (Consult Factory)	MB Matte Black
	CF Custom Finish (Consult Factory)

TBAR Mounting CLIPS >> Surface Mount Top	9/16 Flat Clips	15/16 Flat Clips
LS-SQU-1	Optional*	Standard
LS-SQU-2	Standard	Not Compatible
LS-SQU-3	Optional*	Standard
	*Contact Factory	

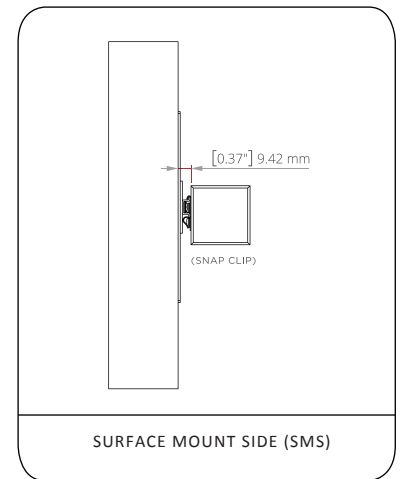

Linear Series - Square 1

DIRECT

STATIC WHITE | FLOOD DIRECT

POWER LEVELS	LIGHT DIRECT LM/4FT	TOTAL LIGHT LM/4FT	ENERGY WATTS/4FT	EFFICACY LPW	CCT/CRI
VL	1983	1983	16	124	4000/80
L	2780	2780	24	116	4000/80
S	3680	3680	32	115	4000/80
H	4428	4428	40	111	4000/80
VH	5342	5342	48	111	4000/80

CCT MULTIPLIERS, STATIC WH

CCT	80CRI	90CRI
2700K	0.93	0.79
3000K	0.96	0.82
3500K	0.97	0.85
4000K	1.00	0.89
5000K	1.01	0.89

DYNAMIC WHITE | FLOOD DIRECT

POWER LEVELS	LIGHT DIRECT LM/4FT	TOTAL LIGHT LM/4FT	ENERGY WATTS/4FT	EFFICACY LPW	CCT/CRI
VL	1392	1392	24	58	4000/90
L	1951	1951	32	61	4000/90
S	2583	2583	36	72	4000/90
H	3108	3108	44	71	4000/90
VH	3749	3749	48	78	4000/90

CCT MULTIPLIERS, DYNAMIC WH

CCT	90CRI
2700K	1.09
3000K	1.08
3500K	1.03
4000K	1.00
5000K	0.99
6500K	0.98

WARM DIM | FLOOD DIRECT

POWER LEVELS	LIGHT DIRECT LM/4FT	TOTAL LIGHT LM/4FT	ENERGY WATTS/4FT	EFFICACY LPW	CCT/CRI
VL	1461	1461	24	61	2700/90
L	2048	2048	32	64	2700/90
S	2712	2712	36	75	2700/90
H	3263	3263	44	74	2700/90
VH	3936	3936	48	82	2700/90

CCT MULTIPLIERS, WARM DIM

CCT	90CRI
1800K	0.02
2250K	0.17
2700K	1.00

RGBW | FLOOD DIRECT

POWER LEVELS	CHANNEL (S)	LIGHT DIRECT LM/4FT	TOTAL LIGHT LM/4FT	ENERGY WATTS/4FT	EFFICACY LPW	CCT
S	White	358	358	10	36	4000
S	All	828	828	20	41	N/A

Linear Series - Square 1

DIRECT

DIRECT OPTICS: LUMEN OUTPUT (PER 4FT)

TYPE	CCT/CRI	ENERGY WATTS/4FT	FLOOD LM/4FT	FLOOD LPW	NARROW FLOOD LM/4FT	NARROW FLOOD LPW	AISLE LIGHTER LM/4FT	AISLE LIGHTER LPW	GRAZE LM/4FT	GRAZE LPW	WALL WASH LM/4FT	WALL WASH LPW
STATIC WHITE	4000K/80	S (32W)	3680	115	4108	128	4235	132	4193	131	3876	121
DYNAMIC WHITE	4000K/90	S (36W)	2583	72	2889	80	2991	83	2957	82	2719	76
WARM DIM	2700K/90	S (36W)	2712	75	3033	84	3140	87	3104	86	2855	79
RGBW	ALL CHANNELS UP	S (20W)	828	41	N/A	N/A	N/A	N/A	N/A	N/A	N/A	N/A

FLOOD*

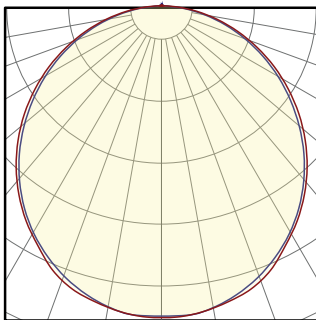

MAX CANDELA: 1277
DELIVERED LUMENS: 3680
WATTS: 32
LPW: 115

NARROW FLOOD*

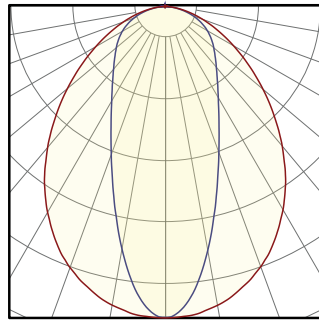

MAX CANDELA: 2692
DELIVERED LUMENS: 4108
WATTS: 32
LPW: 128

AISLE LIGHTER*

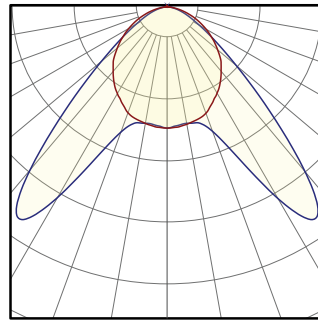

MAX CANDELA: 2371
DELIVERED LUMENS: 4235
WATTS: 32
LPW: 132

WALL GRAZE*

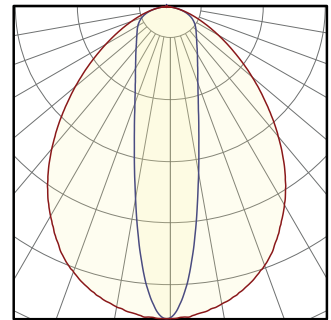

MAX CANDELA: 3701
DELIVERED LUMENS: 4193
WATTS: 32
LPW: 131

WALL WASH*

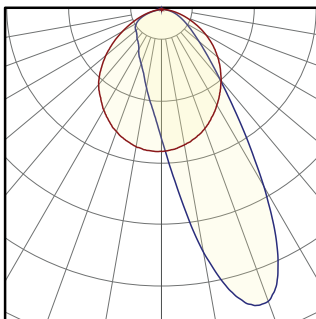

MAX CANDELA: 3478
DELIVERED LUMENS: 3876
WATTS: 32
LPW: 121

CCT MULTIPLIERS STATIC WHITE

CCT	2700K		3000K		3500K		4000K		5000K	
CRI	80	90	80	90	80	90	80	90	80	90
MULTIPLIER	0.93	0.79	0.96	0.82	0.97	0.85	1	0.89	1.01	0.89

CCT MULTIPLIERS DYNAMIC WHITE

CCT	2700K	3000K	3500K	4000K	5000K	6000K
CRI	90	90	90	90	90	90
MULTIPLIER	1.09	1.08	1.03	1	0.99	0.98

CCT MULTIPLIERS WARM DIM

CCT	1800K	2250K	2700K
CRI	90	90	90
MULTIPLIER	0.02	0.17	1

POWER LEVEL MULTIPLIERS

POWER	VL	L	S	H	VH
STATIC WHITE	0.53	0.75	1	1.2	1.45
DYNAMIC WHITE	0.53	0.75	1	1.2	1.45
WARM DIM	0.53	0.75	1	1.2	1.45

*Fixture Properties: 4ft Nominal Length, Standard Output, Static White 4000K/80CRI

Linear Series - Square 1

MOUNTING



**CABLE SUSPENDED (CS)
CABLE SUSPENDED DIRECT (CSD)**
This fixture can be a static down-light: Direct (CSD) or static up-light: Indirect (CSI). Aircraft cables come in 4ft and 8ft lengths and are field adjustable.



SURFACE MOUNT SIDE (SMS)

Surface Mount Side (SMS): the fixture is mounted on the wall & gives a static down-light.



CABLE SUSPENDED - ROTATIONAL (CSR)
Using a similar setup to the Cable Suspended system above, the Cable Suspended - Rotational system has 360 degree rotational capacity with mechanical fasteners to lock fixtures in place if desired. This system offers incredible flexibility, light direction control, and a dynamic aesthetic.

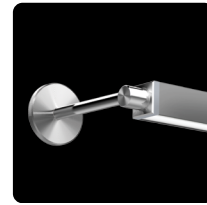

ROTATIONAL ARM MOUNT (RAM)

This system uses 5/8" diameter aluminum arms and subtle details in combination with a 360 degree rotational capacity to create some of the most versatile linear fixtures in the architectural market. Standard mounting uses 3/0 mud rings (supplied by others). Engineered with no visible fasteners, smooth rotation, and mechanical locking, the RAM system reveals an impressive aesthetic with exceptional versatility.

CONTINUOUS RUN (CR)

This fixture has two continuous run connection options. Our single seam continuous run option offers smooth transitions from one section to the next. The joiner bracket and alignment pin system in this option, offers easy to use, confident, single seam connections with a tight fit.

Alternatively, our 360 degree rotational option enables individual sections to rotate independently of each other, which offers adjustable asymmetric light distribution capacity along with striking appearances such as alternating up/down fixtures or spiral transitions. The flexibility within the rotational option makes for infinite design and functional possibilities.



FIXTURE WITH SINGLE SEAM CONTINUOUS RUN



CONTINUOUS RUN ROTATIONAL



CONTINUOUS RUN ROTATIONAL (SPIRAL EFFECT)



CONTINUOUS RUN SINGLE SEAM



FIXTURE WITH CONTINUOUS RUN ROTATIONAL

CANOPIES

44



4" diameter power feed and 4" diameter non-power feed canopy.

41



4" diameter machined power feed and 1-1/4" diameter machined non-power feed canopy. Offers minimal ceiling treatment while maintaining the ability to cover mistakes. Requires a 1/4-20 stud securely fastened to the ceiling.

40



4" diameter machined power feed canopy and no canopy on the non-power feed side. Minimal aesthetic. Requires a 1/4-20 stud securely attached to the ceiling.

44E, 41E, 40E (E) International Canopy**



INTL POWERFEED CANOPY FOR REMOTE DRIVER FIXTURES (PSS CABLE)

This powerfeed canopy replaces the flat style canopy from the North American mounting style (44, 41, & 40) versions pictured)

PROJECT _____

TYPE _____

Linear Series - Square 1

COLOR AND FINISH

Standard luminaire housing finishes are Satin Clear anodized, Matte Black powder coat, and Satin White powder coat. Standard hardware (end caps, knuckles, cover plates, etc.) finishes are Machined Finish, Matte Black powder coat, & Satin White powder coat. Custom anodizing and powder coated finishes are available as well. If you have a particular color/finish treatment in mind, please contact the factory and we will do our best to accommodate your project needs.

LUMINAIRE



SATIN CLEAR ANODIZING

STANDARD



MATTE BLACK



SATIN WHITE

HARDWARE

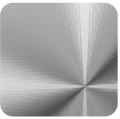

MACHINED COMPONENTS



MATTE BLACK



SATIN WHITE

CUSTOM



BRONZE



COLOR ANODIZE



SPECULAR



RAL COLORS

Linear Series - Square 1

REMOTE DRIVERS HOUSING SIZE

The driver housing length is typically dictated by the options selected. Standard driver housing lengths are as shown. Non standard driver requests may increase or decrease the driver housing length. Specifications are subject to change without notice. Consult factory with questions, requests, or size limitations and we will do our best to accommodate your needs.

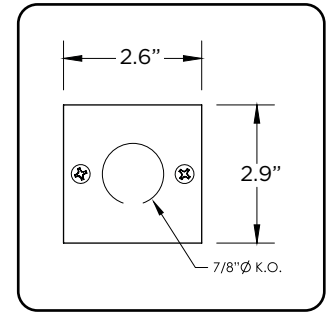
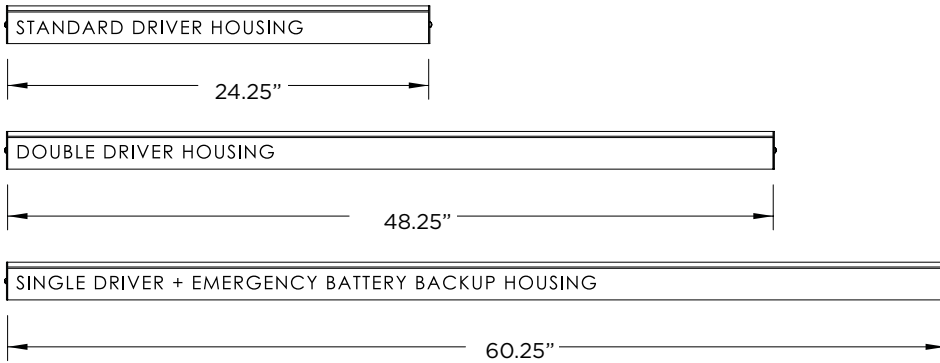

DRIVER HOUSING PROFILE

INSTRUCTIONS

See below for lid removal and installation instructions.

To remove the driver housing lid, use a broad slot screwdriver in the channel as shown here and twist the screwdriver ninety degrees. This may need to be done at both ends of the housing or multiple locations depending on the driver housing length.

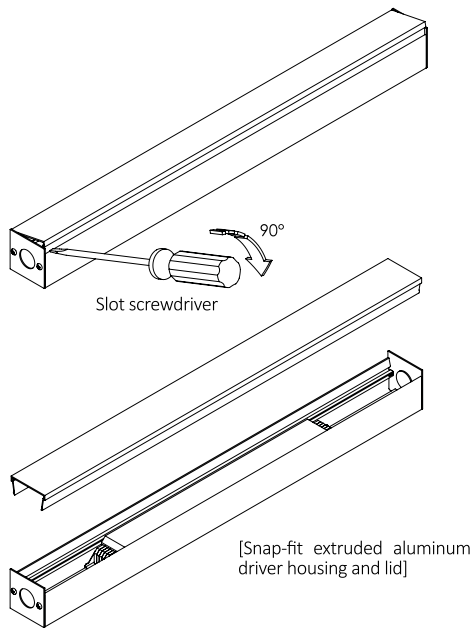

- 1) Drill mounting holes in the driver housing as needed to secure to a suitable surface. (If needed, a power feed hole can be drilled into the bottom of the housing for certain mounting/power feed applications).

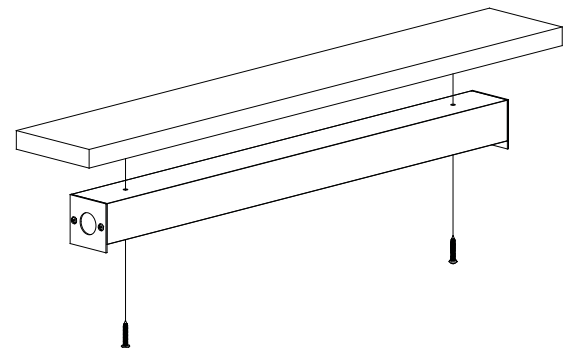

- 2) Secure the housing to the surface. (Fasteners by others)
- 3) Complete wire make-up. Snap extruded lid onto the housing.

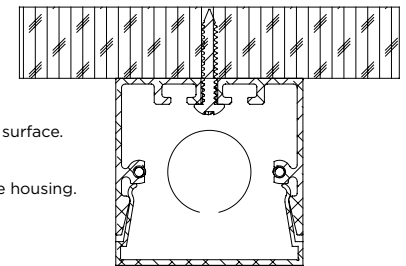

Linear Series - Square 1

WELDED CORNERS

- Luminaire housing is custom mitered & welded for a clean corner appearance
- Lens is also mitered for lens-to-lens interfaces that mirror the mitered housing
- Lens is illuminated to the corner (AKA: lit corners)
- Adjustable aircraft cable suspension system
- High quality powder coated finish (anodized finishes not available with welded custom patterns).

CUSTOMER INSTRUCTIONS

A. Select "CP" option in the ordering block (found in the NOMINAL LENGTH column)

B. Submit simple drawing(s) with the following info:

- Provide number of legs of pattern
- Length of each leg (A, B, C, D, etc)
- Angles of corners (a1, b1, c1, d1, etc)

1. For '3 dimensional' patterns, please provide side view(s) with desired angles, in addition to a top view.

2. Minimum corner angle is 30 degrees.



CUSTOM PATTERN PICTURED

EXAMPLES:

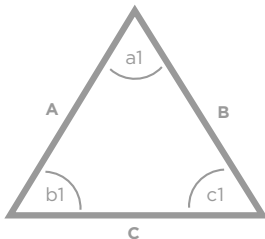

Customer Specification

1. Qty Legs = 3
2. A, B, C = 3ft
3. a1, b1, c1 = 60 deg

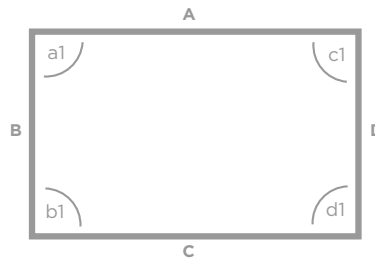

Customer Specification

1. Qty Legs = 4
2. A & C = 8ft, B & D = 4ft
3. a1, b1, c1, d1 = 90 deg

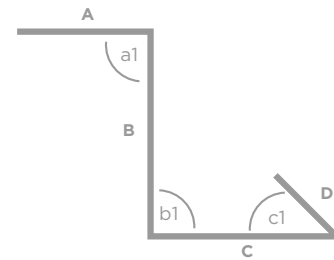

Customer Specification

1. Qty Legs = 4
2. A = 8ft, B = 6ft, C = 6ft, D = 4ft-3in
3. a1 & b1 = 90 deg, c1 = 45 deg