

Linear Series - Round 3

CABLE SUSPENDED

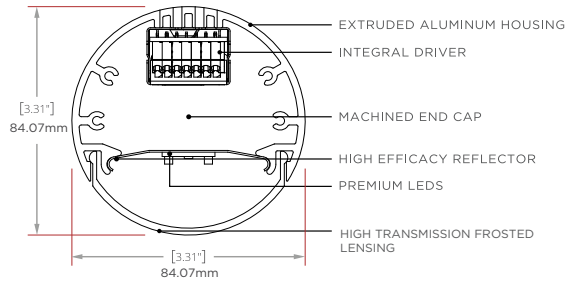

PERFORMANCE

STATIC WHITE | FLOOD DIRECT

POWER LEVELS	LIGHT DIRECT LM/4FT	TOTAL LIGHT LM/4FT	ENERGY WATTS/4FT	EFFICACY LPW	CCT/CRI
VL	2055	2055	16	128	4000/80
L	2881	2881	24	120	4000/80
S	3814	3814	32	119	4000/80
H	4589	4589	40	115	4000/80
VH	5535	5535	48	115	4000/80

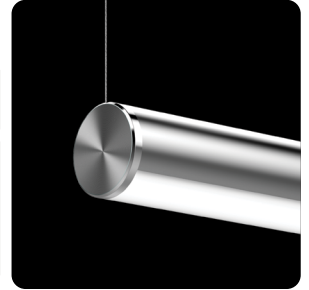

FEATURES:

- HIGH TRANSMISSION FROSTED LENSES
- 1% DIMMING DRIVERS STANDARD
- ADJUSTABLE AIRCRAFT CABLE SUSPENSION SYSTEM
- EXTRUDED ALUMINUM HOUSING WITH NO VISIBLE FASTENERS
- MACHINED ALUMINUM END CAPS WITH EASY ACCESS REMOVAL
- 360 DEGREE ROTATION OPTION WITH MECHANICAL LOCKING

CCT MULTIPLIERS STATIC WHITE

CCT	2700K		3000K		3500K		4000K		5000K	
CRI	80	90	80	90	80	90	80	90	80	90
MULTIPLIER	0.93	0.79	0.96	0.82	0.97	0.85	1	0.89	1.01	0.89

NOTE: ALL ITALICIZED OPTIONS MAY INCREASE LEAD TIMES. PLEASE CONSULT FACTORY WITH QUESTIONS.

FIXTURE MODEL	MOUNTING	NOMINAL LENGTH (FT)	CCT/CRI	DIRECT POWER LEVEL ¹	DIRECT BEAM DISTRIBUTION ¹	DRIVER	HOUSING FINISH
LS-RND-3	CSD Cable Suspended Direct	2	827	VL	Very low	F Flood	SC Satin Clear Anodize SW Satin White Powder Coat MB Matte Black Powder Coat CF Custom Finish (Consult Factory)
		3	830	L	Low		
	CSI Cable Suspended Indirect	4	835	S	Standard		
	CSR Cable Suspended Rotational	5	840	H	High		
		6	850	VH	Very High		
		7	927			1D 0-10V EldoLED 1% OID 0-10V EldoLED 0.1% LDE1 Lutron Ecosystem 1% LDE5 Lutron Ecosystem 5% 1DT (TW) ² 1DW (WD) ² DMX8 Standard 8 bit (RGBW) ¹ DMX16 Optional 16 bit (RGBW) ¹ DALI (INTL) TWS (Sensor Fixtures) ³	
		8	930			1. Driver must reside in remote housing 2. 0-10V input - CHOOSE DALI instead for INTL versions 3. Integrated Sensor options pair with TWS driver only	
		<i>CP^{3,4} Custom Pattern</i> CR^{1,2} Continuous Run (Specify Length in Nominal Feet)	935 940 950				

END CAPS FINISH ¹	CANOPY SIZE	CANOPY FINISH	POWER CORD	CABLE LENGTH	OPTIONS ⁶
MF Machined Finish SW Satin White MB Matte Black CF Custom Finish (Consult Factory)	44 4" Power feed canopy 4" Non-power feed canopy 44E 4" Power feed canopy 4" Non-power feed canopy - International 40 4" Power feed canopy Canopy only at power feed 40E 4" Power feed canopy Canopy only at power feed - International 41 4" Power feed canopy 1" Non-power feed canopy 41E 4" Power feed canopy 1" Non-power feed canopy - International	MF Machine Finish SW Satin White MB Matte Black CF Custom Finish (Consult Factory)	W White G Gray ¹ B Black	4 4' 8 8'	EMB7^{1,3,4,6} 7 Watt battery back-up (Approximately 600 lumens) EMB12^{1,3,4,6} 12 Watt battery back-up (Approximately 1000 lumens) EMW^{1,2} Emergency Circuit Wiring WSN⁶ WSN nLight Sensor WSE⁶ WSE Enlighted Sensor WSW⁶ WSW Wavelinx Sensor WSL⁶ Lutron Vive Sensor

GENERAL NOTES:

All fixtures are UL listed for dry and damp locations. Fixtures with International (E) option designation are CE and ROHS compliant. INTEGRAL DRIVER for all options. Please contact the factory with any specification questions.



FIXTURE ORIENTATION

Direct (CSD) for downlight applications
 Indirect (CSI) for up light applications
 Rotational (CSR) for adjustable applications: 360 degree rotational capacity with locking mechanism.

Linear Series - Round 3

ROTATIONAL ARM MOUNT

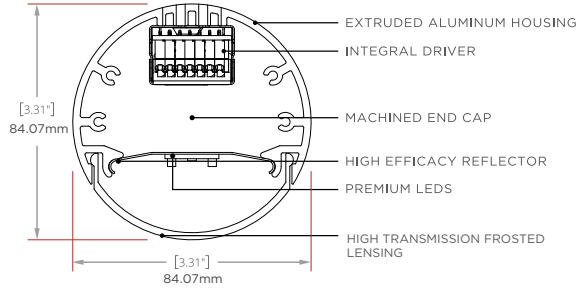

FEATURES:

- 3/4" DIAMETER RIGID TUBE MOUNTING SYSTEM
- HIGH TRANSMISSION FROSTED LENSES
- 1% DIMMING DRIVERS STANDARD
- EXTRUDED ALUMINUM HOUSING WITH NO VISIBLE FASTENERS
- MACHINED ALUMINUM END CAPS WITH EASY ACCESS REMOVAL
- 360 DEGREE ROTATION OPTION WITH MECHANICAL LOCKING

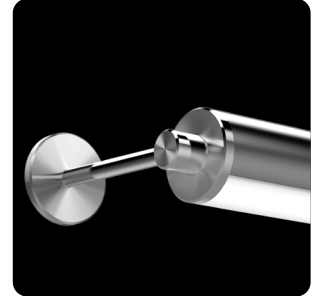

NOTE: ALL ITALICIZED OPTIONS MAY INCREASE LEAD TIMES. PLEASE CONSULT FACTORY WITH QUESTIONS.

FIXTURE MODEL	MOUNTING	NOMINAL LENGTH (FT)	CCT/CRI	DIRECT POWER LEVEL	DIRECT BEAM DISTRIBUTION	DRIVER	HOUSING FINISH
LS-RND-3	RAM Rotational Arm Mount <i>RAME</i> Rotational Arm Mount - International	2 3 4 5 6 7 8 CR ^{1,2} Continuous Run (Specify Length in Nominal Feet)	827 830 835 840 850 927 930 935 940 950 <i>TW2765</i> <i>WD1827</i> <i>RGBW¹</i>	VL Very low L Low S Standard H High VH Very High	F Flood	1D 0-10V EldoLED 1% 01D 0-10V EldoLED 0.1% LDE1 Lutron Ecosystem 1% LDE5 Lutron Ecosystem 5% 1DT (TW) ² 1DW (WD) ² DMX8 Standard 8 bit (RGBW) ¹ DMX16 Optional 16 bit (RGBW) ¹ DALI (INTL) 1WS (Sensor Fixtures) ³	SC Satin Clear Anodize SW Satin White Powder Coat MB Matte Black Powder Coat CF Custom Finish (Consult Factory)
		1. Power feed is always at the first section in a continuous run 2. Rotational mounting w/ CR will have a power feed for every section	1. Pair only w/ power level(s) = S, beams = F			1. Driver must reside in remote housing 2. 0-10V input - CHOOSE DALI instead for INTL versions 3. Integrated Sensor options pair with 1WS driver only	

END CAPS & RAM HARDWARE FINISH	ARM LENGTH NOM (IN)	MOUNTING PLATE	OPTIONS ⁶
MF Machined Finish SW Satin White MB Matte Black CF Custom Finish (Consult Factory)	3 6' 9' 12' 1. Includes Mounting Tieback	4CPF	EMB7 ^{1,3,4,6} 7 Watt battery back-up (Approximately 600 lumens) EMB12 ^{1,3,4,6} 12 Watt battery back-up (Approximately 1000 lumens) EMW ^{1,2} Emergency Circuit Wiring WSN ⁶ WSN nLight Sensor WSE ⁶ WSE Enlighted Sensor WSW ⁶ WSW Wavelinx Sensor WSL ⁶ Lutron Vive Sensor
			1. EMB/EMW only linked to first section of continuous run 2. EMW not available for 2ft/3ft lengths 3. EMB7 & EMB12 - 5ft lengths and up 5. EMB not available for combined 8ft length & VH power 6. Factory EMB and Sensor (WS*) options not avail for INTL

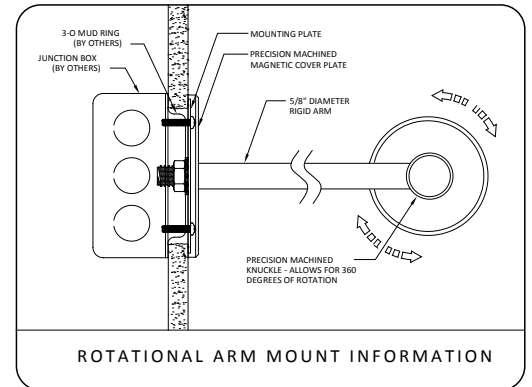

GENERAL NOTES:

All fixtures are UL listed for dry and damp locations. Fixtures with International (E) option designation are CE and ROHS compliant. INTEGRAL DRIVER for all options. Please contact the factory with any specification questions.



Linear Series - Round 3

SURFACE MOUNT

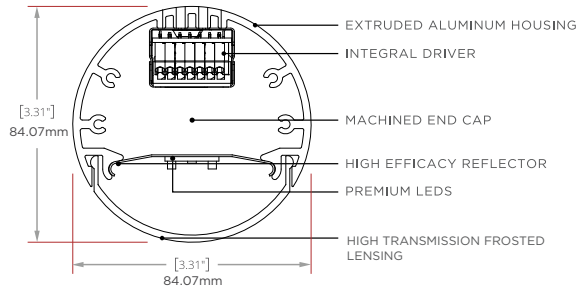

FEATURES:

- CEILING OR WALL MOUNTING SYSTEM
- HIGH TRANSMISSION FROSTED LENSES
- 1% DIMMING DRIVERS STANDARD
- PRE LOCATED FIXTURE HARDWARE FOR EASY SURFACE INSTALL
- EXTRUDED ALUMINUM HOUSING WITH NO VISIBLE FASTENERS
- MACHINED ALUMINUM END CAPS WITH EASY ACCESS REMOVAL



NOTE: ALL ITALICIZED OPTIONS MAY INCREASE LEAD TIMES. PLEASE CONSULT FACTORY WITH QUESTIONS.

FIXTURE MODEL	MOUNTING	NOMINAL LENGTH (FT)	CCT/CRI	DIRECT POWER LEVEL	DIRECT BEAM DISTRIBUTION	DRIVER	HOUSING FINISH						
LS-RND-3	SMS Surface Mount Side	2 3 4 5 6 7 8 CR ¹ Continuous Run (Specify Length in Nominal Feet)	827 830 835 840 850 927 930 935 940 950 TW2765 WD1827 RGBW ¹	VL Very low L Low S Standard H High VH Very High	F Flood	1D 0-10V EldoLED 1% 01D 0-10V EldoLED 0.1% LDE1 Lutron Ecosystem 1% LDE5 Lutron Ecosystem 5% 1DT (TW) ² 1DW (WD) ² DMX8 Standard 8 bit (RGBW) ¹ DMX16 Optional 16 bit (RGBW) ¹ DALI (INTL) TWS (Sensor Fixtures) ³	SC Satin Clear Anodize SW Satin White Powder Coat MB Matte Black Powder Coat CF Custom Finish (Consult Factory)						
	SMSE Surface Mount Side - International												
	SMT Surface Mount Top												
	SMTE Surface Mount Top - International												
	1. Power feed is always at the first section in a continuous run												
	1. Pair only w/ power level(s) = S, beams = F												
	1. Driver must reside in remote housing 2. 0-10V input - CHOOSE DALI instead for INTL versions 3. Integrated Sensor options pair with TWS driver only												

END CAPS FINISH	OPTIONS ⁶
MF Machined Finish SW Satin White MB Matte Black CF Custom Finish (Consult Factory)	EMB7 ^{1,3,4,6} 7 Watt battery back-up (Approximately 600 lumens) EMB12 ^{1,3,4,6} 12 Watt battery back-up (Approximately 1000 lumens) EMW ^{1,2} Emergency Circuit Wiring WSN ⁵ WSN nLight Sensor WSE ⁵ WSE Enlighted Sensor WSW ⁵ WSW Wavelinx Sensor WSL ⁵ Lutron Vive Sensor
1. EMB/EMW only linked to first section of continuous run 2. EMW not available for 2ft/3ft lengths 3. EMB7 & EMB12 - 5ft lengths and up 5. EMB not available for combined 8FT length & VH power 6. Factory EMB and Sensor (WS*) options not avail for INTL	

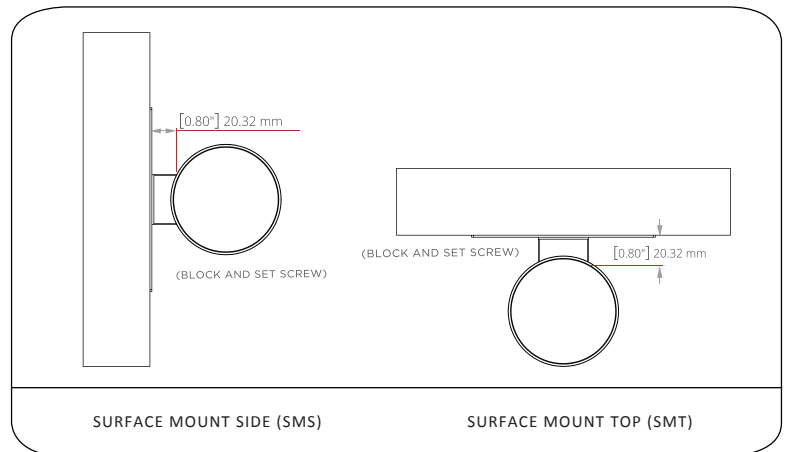

GENERAL NOTES:

All fixtures are UL listed for dry and damp locations. Fixtures with International (E) option designation are CE and ROHS compliant. INTEGRAL DRIVER for all options. Please contact the factory with any specification questions.

PROJECT _____

TYPE _____

Linear Series - Round 3

DIRECT

STATIC WHITE | FLOOD DIRECT

POWER LEVELS	LIGHT DIRECT LM/4FT	TOTAL LIGHT LM/4FT	ENERGY WATTS/4FT	EFFICACY LPW	CCT/CRI
VL	2055	2055	16	128	4000/80
L	2881	2881	24	120	4000/80
S	3814	3814	32	119	4000/80
H	4589	4589	40	115	4000/80
VH	5535	5535	48	115	4000/80

CCT MULTIPLIERS, STATIC WH

CCT	80CRI	90CRI
2700K	0.93	0.79
3000K	0.96	0.82
3500K	0.97	0.85
4000K	1.00	0.89
5000K	1.01	0.89

DYNAMIC WHITE | FLOOD DIRECT

POWER LEVELS	LIGHT DIRECT LM/4FT	TOTAL LIGHT LM/4FT	ENERGY WATTS/4FT	EFFICACY LPW	CCT/CRI
VL	1442	1442	24	60	4000/90
L	2022	2022	32	63	4000/90
S	2677	2677	36	74	4000/90
H	3221	3221	44	73	4000/90
VH	3885	3885	48	81	4000/90

CCT MULTIPLIERS, DYNAMIC WH

CCT	90CRI
2700K	1.09
3000K	1.08
3500K	1.03
4000K	1.00
5000K	0.99
6500K	0.98

WARM DIM | FLOOD DIRECT

POWER LEVELS	LIGHT DIRECT LM/4FT	TOTAL LIGHT LM/4FT	ENERGY WATTS/4FT	EFFICACY LPW	CCT/CRI
VL	1514	1514	24	63	2700/90
L	2123	2123	32	66	2700/90
S	2810	2810	36	78	2700/90
H	3381	3381	44	77	2700/90
VH	4079	4079	48	85	2700/90

CCT MULTIPLIERS, WARM DIM

CCT	90CRI
1800K	0.02
2250K	0.17
2700K	1.00

RGBW | FLOOD DIRECT

POWER LEVELS	CHANNEL (S)	LIGHT DIRECT LM/4FT	TOTAL LIGHT LM/4FT	ENERGY WATTS/4FT	EFFICACY LPW	CCT
S	White	371	371	10	37	4000
S	All	858	858	20	43	N/A

Linear Series - Round 3

DIRECT

DIRECT OPTICS: LUMEN OUTPUT (PER 4FT)

TYPE	CCT/CRI	ENERGY WATTS/4FT	FLOOD LM/4FT	FLOOD LPW
STATIC WHITE	4000K/80	S (32W)	3814	119
DYNAMIC WHITE	4000K/90	S (36W)	2677	74
WARM DIM	2700K/90	S (36W)	2810	78
RGBW	ALL CHANNELS UP	S (20W)	858	43

FLOOD*

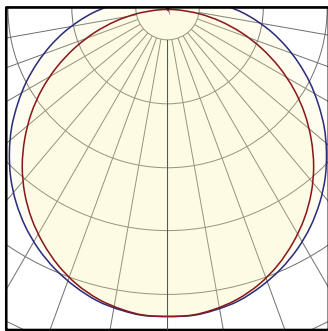

MAX CANDELA: 1093
 DELIVERED LUMENS: 3814
 WATTS: 32
 LPW: 119

*Fixture Properties: 4ft Nominal Length, Standard Output, Static White 4000K/80CRI

CCT MULTIPLIERS STATIC WHITE

CCT	2700K		3000K		3500K		4000K		5000K	
CRI	80	90	80	90	80	90	80	90	80	90
MULTIPLIER	0.93	0.79	0.96	0.82	0.97	0.85	1	0.89	1.01	0.89

CCT MULTIPLIERS DYNAMIC WHITE

CCT	2700K	3000K	3500K	4000K	5000K	6000K
CRI	90	90	90	90	90	90
MULTIPLIER	1.09	1.08	1.03	1	0.99	0.98

CCT MULTIPLIERS WARM DIM

CCT	1800K	2250K	2700K
CRI	90	90	90
MULTIPLIER	0.02	0.17	1

POWER LEVEL MULTIPLIERS

POWER	VL	L	S	H	VH
STATIC WHITE	0.53	0.75	1	1.2	1.45
DYNAMIC WHITE	0.53	0.75	1	1.2	1.45
WARM DIM	0.53	0.75	1	1.2	1.45

Linear Series - Round 3

MOUNTING

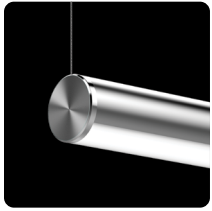

CABLE SUSPENDED DIRECT (CSD) CABLE SUSPENDED INDIRECT (CSI)

This fixture can be a static down-light: Direct (CSD) or static up-light: Indirect (CSI). Aircraft cables come in 4ft and 8ft lengths and are field adjustable.

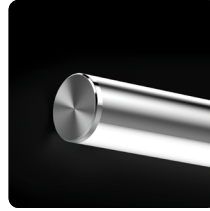

SURFACE MOUNT SIDE (SMS) SURFACE MOUNT TOP (SMT)

Surface Mount Side (SMS) or Side Mount Top (SMT). Side, the fixture is mounted on the wall. Top, the fixture is mounted on the ceiling. Both Side and Top give a static down-light. Top or Side Mount specification denotes the power feed location(s).



CABLE SUSPENDED - ROTATIONAL (CSR)

Using a similar setup to the Cable Suspended system above, the Cable Suspended - Rotational system has 360 degree rotational capacity with mechanical fasteners to lock fixtures in place if desired. This system offers incredible flexibility, light direction control, and a dynamic aesthetic.

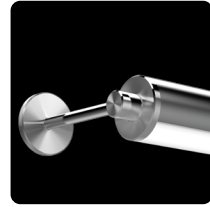

ROTATIONAL ARM MOUNT (RAM)

This system uses 3/4" diameter aluminum arms and subtle details in combination with a 360 degree rotational capacity to create some of the most versatile linear fixtures in the architectural market. Standard mounting uses 3/0 mud rings (supplied by others). Engineered with no visible fasteners, smooth rotation, and mechanical locking, the RAM system reveals an impressive aesthetic with exceptional versatility.

CONTINUOUS RUN (CR)

This fixture has two continuous run connection options. Our single seam continuous run option offers smooth transitions from one section to the next. The joiner bracket and alignment pin system in this option, offers easy to use, confident, single seam connections with a tight fit.

Alternatively, our 360 degree rotational option enables individual sections to rotate independently of each other, which offers adjustable asymmetric light distribution capacity along with striking appearances such as alternating up/down fixtures or spiral transitions. The flexibility within the rotational option makes for infinite design and functional possibilities.

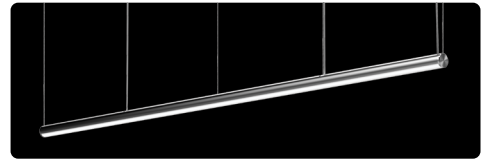

FIXTURE WITH SINGLE SEAM CONTINUOUS RUN



CONTINUOUS RUN ROTATIONAL



CONTINUOUS RUN ROTATIONAL
(SPIRAL EFFECT)



CONTINUOUS RUN
SINGLE SEAM



FIXTURE WITH CONTINUOUS RUN ROTATIONAL

CANOPIES

44



4" diameter power feed and 4" diameter non-power feed canopy.

41



4" diameter machined power feed and 1-1/4" diameter machined non-power feed canopy. Offers minimal ceiling treatment while maintaining the ability to cover mistakes. Requires a 1/4-20 stud securely fastened to the ceiling.

40



4" diameter machined power feed canopy and no canopy on the non-power feed side. Minimal aesthetic. Requires a 1/4-20 stud securely attached to the ceiling.

44E, 41E, 40E (**E) International Canopy



INTL POWERFEED CANOPY FOR
INTEGRAL DRIVER FIXTURES





This powerfeed canopy replaces the flat style canopy from the North American mounting style (44, 41, & 40) versions pictured)

Linear Series - Round 3

COLOR AND FINISH

Standard luminaire housing finishes are Satin Clear anodized, Matte Black powder coat, and Satin White powder coat. Standard hardware (end caps, knuckles, cover plates, etc.) finishes are Machined Finish, Matte Black powder coat, & Satin White powder coat. Custom anodizing and powder coated finishes are available as well. If you have a particular color/finish treatment in mind, please contact the factory and we will do our best to accommodate your project needs.

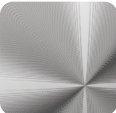
STANDARD

<p>LUMINAIRE</p>  <p>SATIN CLEAR ANODIZING</p>	 <p>RAL 9005 MATTE BLACK</p>	 <p>RAL 9003 SATIN WHITE</p>
<p>HARDWARE</p>  <p>MACHINED COMPONENTS</p>	 <p>RAL 9005 MATTE BLACK</p>	 <p>RAL 9003 SATIN WHITE</p>

CUSTOM

 <p>BRONZE</p>	 <p>COLOR ANODIZE</p>	 <p>SPECULAR</p>	 <p>RAL COLORS</p>
---	--	---	---

SENSORS

Optional fixture integrated sensors and controls offer wireless control system compatibility directly from the factory. Tempo luminaries are now available with integrated control gear from 4 major partners.

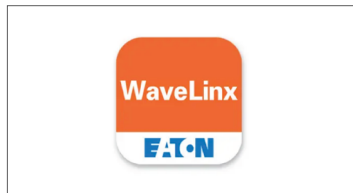

Linear Series - Round 3

WELDED CORNERS

- Luminaire housing is custom mitered & welded for a clean corner appearance
- Lens is also mitered for lens-to-lens interfaces that mirror the mitered housing
- Lens is illuminated to the corner (AKA: lit corners)
- Adjustable aircraft cable suspension system
- High quality powder coated finish (anodized finishes not available with welded custom patterns).

CUSTOMER INSTRUCTIONS

- A. Select "CP" option in the ordering block (found in the NOMINAL LENGTH column)
- B. Submit simple drawing(s) with the following info:
- Provide number of legs of pattern
 - Length of each leg (A, B, C, D, etc)
 - Angles of corners (a1, b1, c1, d1, etc)
1. For '3 dimensional' patterns, please provide side view(s) with desired angles, in addition to a top view.
 2. Minimum corner angle is 30 degrees.



CUSTOM PATTERN PICTURED

EXAMPLES:

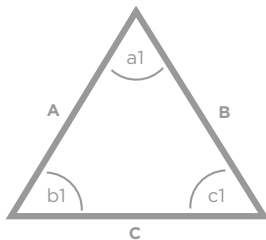

Customer Specification

1. Qty Legs = 3
2. A, B, C = 3ft
3. a1, b1, c1 = 60 deg

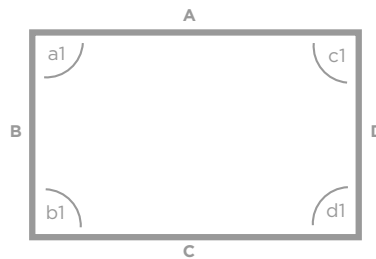

Customer Specification

1. Qty Legs = 4
2. A & C = 8ft, B & D = 4ft
3. a1, b1, c1, d1 = 90 deg

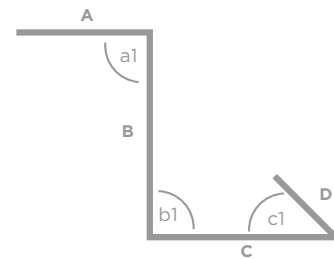

Customer Specification

1. Qty Legs = 4
2. A = 8ft, B = 6ft, C = 6ft, D = 4ft-3in
3. a1 & b1 = 90 deg, c1 = 45 deg