

Linear Series - Rectangle 1

CABLE SUSPENDED

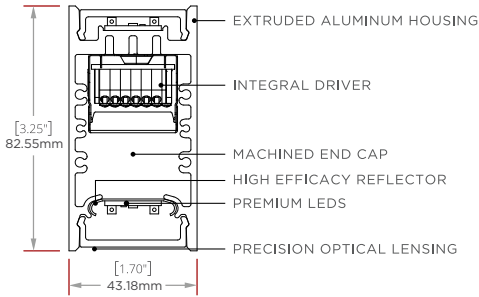

PERFORMANCE

STATIC WHITE | FLOOD DIRECT & FLOOD INDIRECT

POWER LEVELS	LIGHT DIRECT LM/4FT	LIGHT INDIRECT LM/4FT	TOTAL LIGHT LM/4FT	ENERGY WATTS/4FT	EFFICACY LPW	CCT/CRI
VL	1983	2234	4217	32	132	4000/80
L	2780	3132	5912	48	123	4000/80
S	3680	4147	7827	64	122	4000/80
H	4428	4989	9418	80	118	4000/80
VH	5342	6018	11360	96	118	4000/80



CCT MULTIPLIERS STATIC WHITE

CCT	2700K	3000K	3500K	4000K	5000K
CRI	80	90	80	90	80
MULTIPLIER	0.93	0.79	0.96	0.82	0.97

FEATURES:

- PRECISION OPTICAL LENSING OPTIONS OR HIGH TRANSMISSION FROSTED LENSING
- 1% DIMMING DRIVERS STANDARD
- ADJUSTABLE AIRCRAFT CABLE SUSPENSION SYSTEM
- EXTRUDED ALUMINUM HOUSING WITH NO VISIBLE FASTENERS
- MACHINED ALUMINUM END CAPS WITH EASY ACCESS REMOVAL
- BI-DIRECTIONAL FIXTURE
- UGR<19 IN SELECT OUTPUTS AND CONFIGURATIONS



NOTE: ALL ITALICIZED OPTIONS MAY INCREASE LEAD TIME. PLEASE CONTACT THE FACTORY WITH QUESTIONS.

FIXTURE MODEL	MOUNTING	NOMINAL LENGTH (FT)	CCT/CRI	DIRECT POWER LEVEL ¹	DIRECT BEAM DISTRIBUTION	INDIRECT POWER LEVEL ¹	INDIRECT BEAM DISTRIBUTION ¹	DRIVER
LS-RCT-1	CS Cable Suspended <i>CSD Cable Suspended Direct Only</i>	2 3 4 5 6 7 8 <i>CP^{3,4} Custom Pattern</i> CR¹ Continuous Run (Specify Length in Nominal Feet)	827 830 835 840 850 927 930 935 940 950 <i>TW2765</i> <i>WD1827</i> <i>RGBW¹</i>	VL Very low L Low S Standard H High VH Very High	G Graze N Narrow F Flood W Wall Wash A Aisle	VL Very low L Low S Standard H High VH Very High	F Flood B Batwing	1D 0-10V EldoLED 1% <i>01D</i> 0-10V EldoLED 0.1% <i>LDE1</i> Lutron Ecosystem 1% <i>LDES</i> Lutron Ecosystem 5% <i>1DT (TW)²</i> <i>1DW (WD)²</i> <i>DMX8</i> Standard 8 bit (RGBW) [*] <i>DMX16</i> Optional 16 bit (RGBW) [*] <i>DALI (INTL)</i> <i>IWS (Sensor Fixtures)³</i>
		1. Power feed is always first section in a continuous run 3. See final page for CP specifications guide 4. Finish must be powdercoated.	1. Pair only w/ power level(s) = S, beams = F	1.2ft & 3ft - must have same power output for up and down	1.2ft & 3ft - must have same power output for up and down	1. Driver must reside in remote housing 2. 0-10V input - CHOOSE DALI instead for INTL versions 3. Integrated Sensor options pair with IWS driver only		

HOUSING FINISH	END CAPS FINISH	CANOPY FINISH	POWER CORD	CABLE LENGTH	OPTIONS ⁶
SC Satin Clear Anodize SW Satin White Powder Coat MB Matte Black Powder Coat <i>CF Custom Finish (Consult Factory)</i>	MF Machined Finish SW Satin White MB Matte Black <i>CF Custom Finish (Consult Factory)</i>	MF Machine Finish SW Satin White MB Matte Black <i>CF Custom Finish (Consult Factory)</i>	W White G Gray ¹ B Black	4' 4" 8' 8"	EMB7^{1,3,6} 7 Watt battery back-up (Approximately 600 lumens) EMB12^{1,4,6} 12 Watt battery back-up (Approximately 1000 lumens) EMW^{1,2} Emergency Circuit Wiring <i>WSE⁵ WSE Enlightened Sensor</i> <i>WSW⁶ WSW Wavelinx Sensor</i> <i>Dual Dual Circuit</i>
			1. Not available for INTL		1. EMB/EMW only linked to first section of continuous run 2. EMW not available for 2ft/3ft lengths 3. EMB7 - 6ft and up 4. EMB12 - 7ft and up 5. EMB not available for combined 8FT length & VH power 6. Factory EMB and Sensor (WS*) options not avail for INTL

GENERAL NOTES:

All fixtures are UL listed for dry and damp locations. Fixtures with International (E) option designation are CE and ROHS compliant. INTEGRAL DRIVER for all options. Please contact the factory with any specification questions.



FIXTURE ORIENTATION:

Bidirectional (CS) for downlight and uplight applications.

Linear Series - Rectangle 1

SURFACE MOUNT

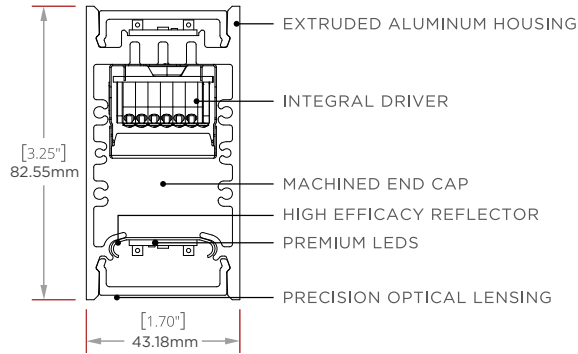

FEATURES:

- WALL MOUNTING SYSTEM WITH PRE LOCATED FIXTURE HARDWARE FOR EASY SURFACE INSTALL
- PRECISION OPTICAL LENSING OPTIONS OR HIGH TRANSMISSION FROSTED LENSING
- 1% DIMMING DRIVERS STANDARD
- EXTRUDED ALUMINUM HOUSING WITH NO VISIBLE FASTENERS
- MACHINED ALUMINUM END CAPS WITH EASY ACCESS REMOVAL



NOTE: ALL ITALICIZED OPTIONS MAY INCREASE LEAD TIME. PLEASE CONTACT THE FACTORY WITH QUESTIONS.

FIXTURE MODEL	MOUNTING	NOMINAL LENGTH (FT)	CCT/CRI	DIRECT POWER LEVEL ¹	DIRECT BEAM DISTRIBUTION	INDIRECT POWER LEVEL ¹	INDIRECT BEAM DISTRIBUTION	DRIVER
LS-RCT-1	SMS Surface Mount Side <i>SMSE</i> Surface Mount Side - International SMSD Surface Mount Side Direct <i>SMSDE</i> Surface Mount Side Direct - International	2 3 4 5 6 7 8 CR¹ Continuous Run (Specify Length in Nominal Feet)	827 830 835 840 850 927 930 935 940 950 <i>TW2765</i> <i>WD1827</i> <i>RGBW¹</i>	VL Very low L Low S Standard H High VH Very High	G Graze N Narrow Flood F Flood W Wall Wash A Aisle	VL Very low L Low S Standard H High VH Very High	F Flood B Batwing	1D 0-10V EldoLED 1% <i>01D</i> 0-10V EldoLED 0.1% <i>LDE1</i> Lutron Ecosystem 1% <i>LDE5</i> Lutron Ecosystem 5% <i>1DT</i> (TW) ² <i>1DW</i> (WD) ² <i>DMX8</i> Standard 8 bit (RGBW) [*] <i>DMX16</i> Optional 16 bit (RGBW) [*] <i>DALI</i> (INTL) <i>TWS</i> (Sensor Fixtures) ³ 1. Driver must reside in remote housing 2. 0-10V input - CHOOSE DALI instead for INTL versions
		1. Power feed is always at the first section in a continuous run 3. See final page for CP specifications guide	1. Pair only w/ power level(s) = S, beams = F	1. 2ft & 3ft - must have same power output for up and down	1. 2ft & 3ft - must have same power output for up and down	1. 2ft & 3ft - must have same power output for up and down		

HOUSING FINISH	END CAPS FINISH	OPTIONS ⁶
SC Satin Clear Anodize SW Satin White Powder Coat MB Matte Black Powder Coat <i>CF</i> Custom Finish (Consult Factory)	MF Machined Finish SW Satin White MB Matte Black <i>CF</i> Custom Finish (Consult Factory)	EMB7^{1,3,6} 7 Watt battery back-up (Approximately 600 lumens) EMB12^{1,4,6} 12 Watt battery back-up (Approximately 1000 lumens) EMW^{1,2} Emergency Circuit Wiring <i>WSE⁶</i> WSE Enlighted Sensor <i>WSW⁶</i> WSW Wavelinx Sensor <i>Dual</i> Dual Circuit 1. EMB/EMW only linked to first section of continuous run 2. EMW not available for 2ft/3ft lengths 3. EMB7 & EMB12 - 6ft lengths and up 4. EMB12 - 7ft and up 5. EMB not available for combined 8ft length & VH power 6. Factory EMB and Sensor (WS*) options not avail for INTL

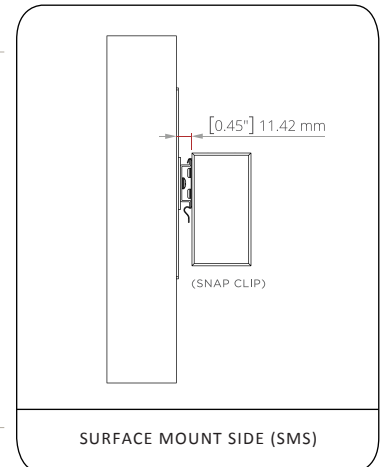

GENERAL NOTES:

All fixtures are UL listed for dry and damp locations. Fixtures with International (E) option designation are CE and ROHS compliant. INTEGRAL DRIVER for all options. Please contact the factory with any specification questions.



Linear Series - Rectangle 1

BIDIRECTIONAL

STATIC WHITE | FLOOD DIRECT & FLOOD INDIRECT

POWER LEVELS	LIGHT DIRECT LM/4FT	LIGHT INDIRECT LM/4FT	TOTAL LIGHT LM/4FT	ENERGY WATTS/4FT	EFFICACY LPW	CCT/CRI
VL	1983	2234	4217	32	132	4000/80
L	2780	3132	5912	48	123	4000/80
S	3680	4147	7827	64	122	4000/80
H	4428	4989	9418	80	118	4000/80
VH	5342	6018	11360	96	118	4000/80

CCT MULTIPLIERS, STATIC WH

CCT	80CRI	90CRI
2700K	0.93	0.79
3000K	0.96	0.82
3500K	0.97	0.85
4000K	1.00	0.89
5000K	1.01	0.89

DYNAMIC WHITE | FLOOD DIRECT & FLOOD INDIRECT

POWER LEVELS	LIGHT DIRECT LM/4FT	LIGHT INDIRECT LM/4FT	TOTAL LIGHT LM/4FT	ENERGY WATTS/4FT	EFFICACY LPW	CCT
VL	1392	1568	2960	48	62	4000/90
L	1951	2198	4149	64	65	4000/90
S	2583	2910	5493	72	76	4000/90
H	3108	3502	6610	88	75	4000/90
VH	3749	4224	7973	96	83	4000/90

CCT MULTIPLIERS, DYNAMIC WH

CCT	90CRI
2700K	1.09
3000K	1.08
3500K	1.03
4000K	1.00
5000K	0.99
6500K	0.98

WARM DIM | FLOOD DIRECT & FLOOD INDIRECT

POWER LEVELS	LIGHT DIRECT LM/4FT	LIGHT INDIRECT LM/4FT	TOTAL LIGHT LM/4FT	ENERGY WATTS/4FT	EFFICACY LPW	CCT
VL	1461	1646	3108	48	65	2700/90
L	2048	2308	4356	64	68	2700/90
S	2712	3055	5767	72	80	2700/90
H	3263	3676	6940	88	79	2700/90
VH	3936	4435	8371	96	87	2700/90

CCT MULTIPLIERS, WARM DIM

CCT	90CRI
1800K	0.02
2250K	0.17
2700K	1.00

RGBW | FLOOD DIRECT & FLOOD INDIRECT

POWER LEVELS	CHANNEL (S)	LIGHT DIRECT LM/4FT	LIGHT INDIRECT LM/4FT	TOTAL LIGHT LM/4FT	ENERGY WATTS/4FT	EFFICACY LPW	CCT
S	White	358	404	762	20	38	4000
S	All	828	933	1762	40	44	N/A

Linear Series - Rectangle 1

DIRECT

DIRECT OPTICS: LUMEN OUTPUT (PER 4FT)

TYPE	CCT/CRI	ENERGY WATTS/4FT	FLOOD LM/4FT	FLOOD LPW	NARROW FLOOD LM/4FT	NARROW FLOOD LPW	AISLE LIGHTER LM/4FT	AISLE LIGHTER LPW	GRAZE LM/4FT	GRAZE LPW	WALL WASH LM/4FT	WALL WASH LPW
STATIC WHITE	4000K/80	S (32W)	3680	115	4108	128	4235	132	4193	131	3876	121
DYNAMIC WHITE	4000K/90	S (36W)	2583	72	2889	80	2991	83	2957	82	2719	76
WARM DIM	2700K/90	S (36W)	2712	75	3033	84	3140	87	3104	86	2855	79
RGBW	ALL CHANNELS UP	S (20W)	828	41	N/A	N/A	N/A	N/A	N/A	N/A	N/A	N/A

FLOOD*

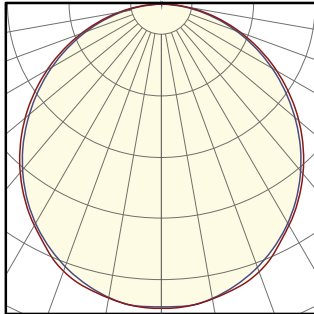

MAX CANDELA: 1283
DELIVERED LUMENS: 3680
WATTS: 32
LPW: 115

NARROW FLOOD*

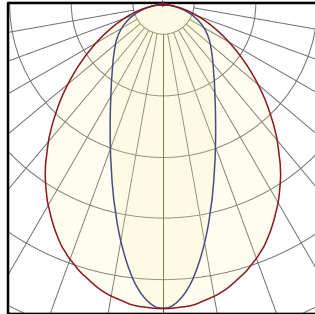

MAX CANDELA: 2701
DELIVERED LUMENS: 4108
WATTS: 32
LPW: 128

AISLE LIGHTER*

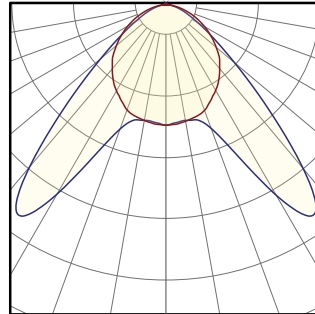

MAX CANDELA: 2378
DELIVERED LUMENS: 4235
WATTS: 32
LPW: 132

WALL GRAZE*

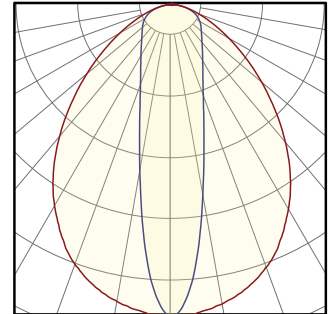

MAX CANDELA: 3714
DELIVERED LUMENS: 4193
WATTS: 32
LPW: 131

WALL WASH*

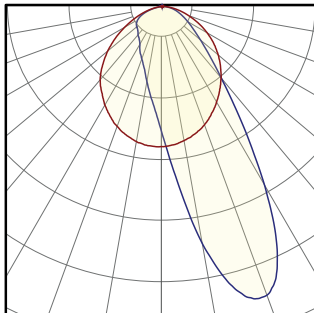

MAX CANDELA: 3491
DELIVERED LUMENS: 3876
WATTS: 32
LPW: 121

CCT MULTIPLIERS STATIC WHITE

CCT	2700K		3000K		3500K		4000K		5000K	
CRI	80	90	80	90	80	90	80	90	80	90
MULTIPLIER	0.93	0.79	0.96	0.82	0.97	0.85	1	0.89	1.01	0.89

CCT MULTIPLIERS DYNAMIC WHITE

CCT	2700K	3000K	3500K	4000K	5000K	6000K
CRI	90	90	90	90	90	90
MULTIPLIER	1.09	1.08	1.03	1	0.99	0.98

CCT MULTIPLIERS WARM DIM

CCT	1800K	2250K	2700K
CRI	90	90	90
MULTIPLIER	0.02	0.17	1

POWER LEVEL MULTIPLIERS

POWER	VL	L	S	H	VH
STATIC WHITE	0.53	0.75	1	1.2	1.45
DYNAMIC WHITE	0.53	0.75	1	1.2	1.45
WARM DIM	0.53	0.75	1	1.2	1.45

*Fixture Properties: 4ft Nominal Length, Standard Output, Static White 4000K/80CRI

Linear Series - Rectangle 1

INDIRECT

INDIRECT OPTICS: LUMEN OUTPUT (PER 4FT)

TYPE	CCT/CRI	ENERGY WATTS/4FT	FLOOD LM/4FT	FLOOD LPW	BATWING LM/4FT	BATWING LPW
STATIC WHITE	4000K/80	S (32W)	4147	130	4105	128
DYNAMIC WHITE	4000K/90	S (36W)	2910	81	2874	80
WARM DIM	2700K/90	S (36W)	3055	85	3018	84
RGBW	ALL CHANNELS UP	S (20W)	933	47	N/A	N/A

FLOOD*

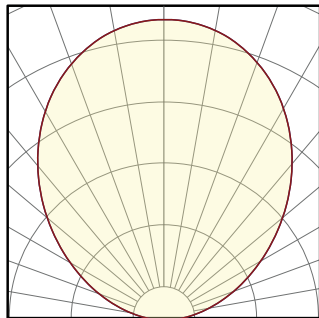

MAX CANDELA: 1639
DELIVERED LUMENS: 4147
WATTS: 32
LPW: 130

BATWING*

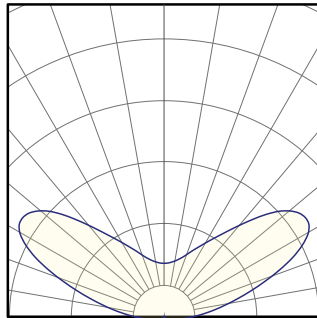

MAX CANDELA: 1681
DELIVERED LUMENS: 4105
WATTS: 32
LPW: 128

LUMINAIRE TOTAL LUMENS PER WATT

$$\frac{(\text{DIRECT LUMENS/FT} + \text{INDIRECT LUMENS/FT}) \times \text{FIXTURE TOTAL LINEAR FT}}{(\text{DIRECT WATTS/FT} + \text{INDIRECT WATTS/FT}) \times \text{FIXTURE TOTAL LINEAR FT}} = \text{TOTAL LUMINAIRE LUMENS PER WATT}$$

*Fixture Properties: 4ft Nominal Length, Standard Output, Static White 4000K/80CRI

CCT MULTIPLIERS STATIC WHITE

CCT	2700K		3000K		3500K		4000K		5000K	
CRI	80	90	80	90	80	90	80	90	80	90
MULTIPLIER	0.93	0.79	0.96	0.82	0.97	0.85	1	0.89	1.01	0.89

CCT MULTIPLIERS DYNAMIC WHITE

CCT	2700K	3000K	3500K	4000K	5000K	6000K
CRI	90	90	90	90	90	90
MULTIPLIER	1.09	1.08	1.03	1	0.99	0.98

CCT MULTIPLIERS WARM DIM

CCT	1800K	2250K	2700K
CRI	90	90	90
MULTIPLIER	0.02	0.17	1

POWER LEVEL MULTIPLIERS

POWER	VL	L	s	H	VH
STATIC WHITE	0.53	0.75	1	1.2	1.45
DYNAMIC WHITE	0.53	0.75	1	1.2	1.45
WARM DIM	0.53	0.75	1	1.2	1.45

Linear Series - Rectangle 1

PROJECT _____

TYPE _____

MOUNTING



CABLE SUSPENDED (CS)

This fixture can be a cable suspended down-light and up-light: Bi-Directional (CS), or can be special ordered as a cable suspended static down-light only: Direct Only (CSD). Aircraft cables come in 4ft and 8ft lengths and are field adjustable.



SURFACE MOUNT SIDE (SMS)

Surface Mount Side (SMS). The fixture is mounted on the wall using mounting brackets, giving a static bi-directional up-light and down-light.

CONTINUOUS RUN (CR)

Our single seam continuous run option offers smooth transitions from one section to the next. Our joiner bracket and alignment pin system offers easy to use, confident, single seam connections with a tight fit.



CONTINUOUS RUN
SINGLE SEAM



FIXTURE WITH SINGLE SEAM CONTINUOUS RUN

CANOPIES

SATIN WHITE (SW)

MATTE BLACK

MACHINE FINISH (MF)



44



4" diameter power feed and 4" diameter non-power feed canopy.

40



4" diameter machined power feed canopy and no canopy on the non-power feed side. Minimal aesthetic. Requires a 1/4-20 stud securely attached to the ceiling.

41



4" diameter machined power feed and 1-1/4" diameter machined non-power feed canopy. Offers minimal ceiling treatment while maintaining the ability to cover mistakes. Requires a 1/4-20 stud securely fastened to the ceiling.

44E, 41E, 40E
(**E) International Canopy











INTL POWERFEED
CANOPY FOR INTEGRAL
DRIVER FIXTURES

This powerfeed canopy replaces the flat style canopy from the North American mounting style (44, 41, & 40) versions pictured)

Linear Series - Rectangle 1

COLOR AND FINISH

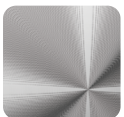
Standard luminaire housing finishes are Satin Clear anodized, Matte Black powder coat, and Satin White powder coat. Standard hardware (end caps, knuckles, cover plates, etc.) finishes are Machined Finish, Matte Black powder coat, & Satin White powder coat. Custom anodizing and powder coated finishes are available as well. If you have a particular color/finish treatment in mind, please contact the factory and we will do our best to accommodate your project needs.

STANDARD			CUSTOM			
LUMINAIRE						
						
SATIN CLEAR ANODIZING	MATTE BLACK RAL 9005	SATIN WHITE RAL 9003	BRONZE	COLOR ANODIZE	SPECULAR	RAL COLORS
HARDWARE						
						
MACHINED COMPONENTS	MATTE BLACK RAL 9005	SATIN WHITE RAL 9003				

SENSORS

Optional fixture integrated sensors and controls offer wireless control system compatibility directly from the factory. Tempo luminaries are now available with integrated control gear from 4 major partners.

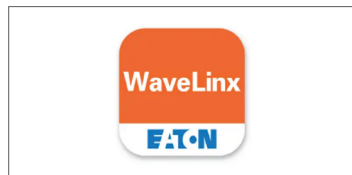

Linear Series - Rectangle 1

WELDED CORNERS

- Luminaire housing is custom mitered & welded for a clean corner appearance
- Lens is also mitered for lens-to-lens interfaces that mirror the mitered housing
- Lens is illuminated to the corner (AKA: lit corners)
- Adjustable aircraft cable suspension system
- High quality powder coated finish (anodized finishes not available with welded custom patterns).

CUSTOMER INSTRUCTIONS

A. Select "CP" option in the ordering block (found in the NOMINAL LENGTH column)

B. Submit simple drawing(s) with the following info:

- Provide number of legs of pattern
- Length of each leg (A, B, C, D, etc)
- Angles of corners (a1, b1, c1, d1, etc)

1. For '3 dimensional' patterns, please provide side view(s) with desired angles, in addition to a top view.

2. Minimum corner angle is 30 degrees.



CUSTOM PATTERN PICTURED

EXAMPLES:

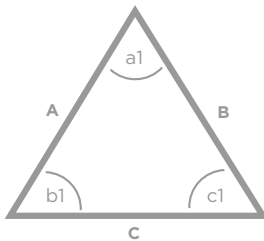

Customer Specification

1. Qty Legs = 3
2. A, B, C = 3ft
3. a1, b1, c1 = 60 deg

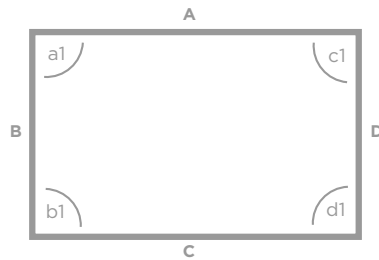

Customer Specification

1. Qty Legs = 4
2. A & C = 8ft, B & D = 4ft
3. a1, b1, c1, d1 = 90 deg

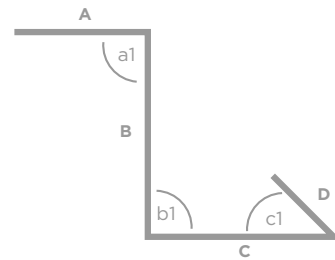

Customer Specification

1. Qty Legs = 4
2. A = 8ft, B = 6ft, C = 6ft, D = 4ft-3in
3. a1 & b1 = 90 deg, c1 = 45 deg